



<b>1.</b>	<b>THE MEASURING SYSTEM INTRODUCES ITSELF .....</b>	<b>4</b>
<b>2.</b>	<b>THE DEMO PROGRAM .....</b>	<b>6</b>
2.1	INSTALLATION OF THE SOFTWARE .....	6
2.2	ACTIVATION .....	8
2.3	EASY MODE MEASUREMENT .....	9
<b>3.</b>	<b>SETTING.....</b>	<b>15</b>
3.1	PROFILE.....	15
3.2	TAB ABOUT .....	16
3.3	TAB ACOUSTICS .....	17
3.4	TAB ELECTRONICS .....	19
3.5	TEST-ADAPTER.....	21
<b>4.</b>	<b>MANAGEMENT .....</b>	<b>25</b>
4.1	LABELLING.....	25
4.2	MEASUREMENT.....	26
4.3	MEASURING FUNCTIONS .....	27
<b>5.</b>	<b>CONTROLS.....</b>	<b>28</b>
5.1	CONTROLLER.....	28
5.2	INPUT WINDOW.....	31
5.3	DATA LINES.....	32
5.4	DIAGRAM HEADER.....	36
5.5	DIAGRAM FOOTER.....	37
5.6	DIAGRAM MANAGEMENT .....	37
5.7	VOLTMETER.....	41
5.8	GENERATOR.....	41
5.9	THE ATB SIGNAL .....	42
<b>6.</b>	<b>PHASE MEASUREMENT .....</b>	<b>44</b>
6.1	BASICS .....	44
6.2	THE PHASE AT THE LOUDSPEAKER.....	46
6.3	PHASE DIAGRAM .....	47
6.3	ELEKTRISCHE PHASENMESSUNG.....	48
6.4	ACOUSTIC PHASE MEASUREMENT.....	49
6.5	IMPEDANCE PHASE MEASUREMENT .....	49
<b>7.</b>	<b>OSCILLOSCOPE.....</b>	<b>50</b>
7.1	GENERATOR.....	50
7.2	VOLTMETER.....	51
7.3	MESSUNGEN.....	51
7.4	STEP RESPONSE .....	53
7.5	DYNAMIC MEASUREMENT.....	55
<b>8.</b>	<b>DISTANCE METER.....</b>	<b>57</b>
8.1	OPENING THE MEASUREMENT.....	57
8.2	LATENCY .....	60
<b>9.</b>	<b>MAGNITUDE .....</b>	<b>64</b>
9.1	FREQUENCY RESPONDS.....	64
9.2	PHASE .....	65
<b>10.</b>	<b>IMPEDANCE METER.....</b>	<b>66</b>

<b>11.</b>	<b>THIELE-SMALL PARAMETER .....</b>	<b>68</b>
<b>12.</b>	<b>SOUND PRESSOR LEVEL METER, SPL .....</b>	<b>69</b>
12.1	FREQUENCY RESPONSE MEASUREMENT .....	70
12.2	ANECHOIC MEASUREMENT .....	74
12.3	SUM, COMBINE, IMPEDANCE .....	75
12.4	SMOOTHING.....	79
12.5	PHASE MEASUREMENT .....	79
12.6	LOUDSPEAKER MEASUREMENT TECHNOLOGY .....	80
12.7	MEASUREMENTS IN THE CAR.....	81
12.8	REALTIME ANALYZER, RTA.....	81
12.9	SPEKTRUM ANALYZER .....	82
<b>13.</b>	<b>IMPULS RESPONSE .....</b>	<b>84</b>
<b>14.</b>	<b>TOTAL HARMONIC DISTORTION, THD.....</b>	<b>85</b>
<b>15.</b>	<b>WATERFALL, DECAY SPECTRUM.....</b>	<b>87</b>
15.1	BASICS.....	87
15.2	MEASUREMENT .....	91
<b>16.</b>	<b>REVERBIRATION TIME.....</b>	<b>95</b>
16.1	THE MEASUREMENT.....	95
<b>17.</b>	<b>MEASUREMENT WITH OWN SIGNALS .....</b>	<b>98</b>
<b>19.</b>	<b>BLUETOOTH DEVICE MEASUREMENT .....</b>	<b>100</b>
<b>19.</b>	<b>ANNEX .....</b>	<b>101</b>
19.1	MEASUREMENTS WITH CD IN THE CAR .....	101
19.2	ROOM CORRECTION.....	101
19.3	NEAR-FIELD MEASUREMENT .....	102
19.4	SETTING OF THE SURROUND SYSTEM WITH DVD.....	103
18.9	SETTING THE HIFI STEREO SYSTEM.....	111
<b>20.</b>	<b>ACCESSORIES.....</b>	<b>115</b>

## 1. THE MEASURING SYSTEM INTRODUCES ITSELF

The ATB Audio Analyzer measurement program forms an accurate and comprehensive 2-channel audio analyzer with PC and sound card. The sound card can be an internal or external USB sound card.

For the layman interested in measurement technology, the program has the EASY MODE function. For the user interested in the loudspeaker technology and acoustics there is the photo story on the web page of Kirchner elektronik under worth knowing, <https://kirchner-elektronik.de/fotostory/>.

The ATB Audio Analyzer program together with an ATB USB device forms the most favorable standard for the professional acoustic measuring technique. Unique is the accuracy of the time-dependent measurements like oscilloscope, waterfall and electrical or acoustic phase measurement. To make this possible with the Windows software and the USB sound card hardware, the Time Calibration measurement was developed.

Both common measurement methods of audio measurement technology are available for frequency and phase response measurement. A noise signal, here ATB, or the sine sweep is used as the measurement signal. Measurements with noise signal are known from the measuring systems with LMS, MLSSA, Clio and ATB measuring signal. The sine sweep is used with the Klippel measuring system. The THD measurement uses the signal LMS for the decay spectrum, also called waterfall, the measurement with the cos-burst is advantageous. In addition to the decay behaviour, the measurement also shows the transient response. By scaling the time axis in periods, the frequency range from 5Hz - 24kHz can be mapped and evaluated.

Extensive automatic calibration of the sound card results in a very accurate measurement system. Input and output voltages show the real values. According to the sound card, 24bit accuracy with 192 kHz is possible.

For the settings of a surround system, the signals for the individual channels are generated.

- Automatic calibration with the Time Calibration function.
- Frequency and phase responses are measured by analysing with the correlation and the measurement signal ATB periodic noise and Long chirp sine. The acoustic, electrical and impedance measurements have their own menus.
- SPL with anechoic function for quasi room-independent measurement
- High-resolution frequency analyser and real-time analyser with third-octave display (RTA)
- Distortion measurement with display of THD or 2nd, 3rd, 4th, 5th order harmonics.
- Memory oscilloscope with sophisticated trigger function and synchronisation with the generator.
- Generator for sine, square and cosine-burst and as continuous signal or as burst with selectable period

length. Pulse for dynamic measurement analysis. Output of the surround channels, depending on the sound card. Bluetooth output

- Waterfall diagram with cosine burst measurement signal for displaying transient behaviour as well as resonances and reflections separately.
- Waterfall with wavelet analysis.
- Reverberation Time, RT60, conforming to DIN,ISO

Frequency response measurements with Auto-Test CD or Surround-Test DVD

The ATB Audio Analyzer measuring programme is as easy to use as the most modern measuring technology. This means that the measuring system can also be used by the interested layman.

The user interface of the ATB Audio Analyzer measuring programme is optimised for tablet operation with touch screen.

The special measuring technique allows frequency response measurement even with a CD or USB stick in the car or a DVD for the surround system. The DVD is simply played in the DVD, Blu-ray. It also contains signals for aural checks of the surround reproduction. The Audio Analyzer is used for the development of loudspeakers, the optimisation of room acoustics, the installation of car hi-fi systems and the calibration of surround systems. The programme contains extensive storage options. Several functions support the documentation. By saving in text format, the data can be further processed with CAD programmes or stored in existing databases.

The programme runs under Windows 7, 8, Vista and 10, 11.

## 2. THE DEMO PROGRAM



The button shows the demo version

The demo program is free of charge.

The program is a full version for 30 days

### 2.1 INSTALLATION OF THE SOFTWARE

The installation programme is called up with the following link

<https://kirchner-elektronik.de/download/>

**Download**

#### ^ Demoprogramm

##### ATB Audio Analyzer Demoprogramm

Für moderne Rechner wird die 64bit Version geladen

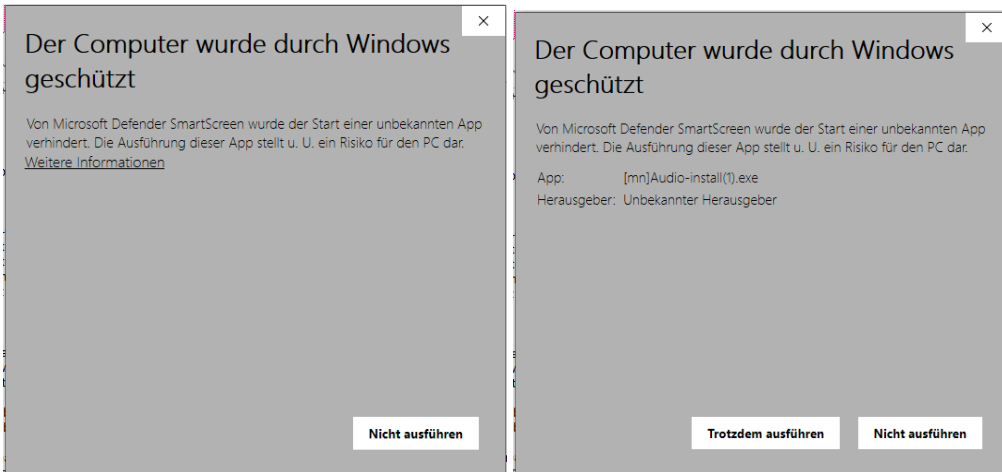
[Kostenloser Download für 64bit](#)

Alte Rechner benötigen die 32bit Version, selten

[Kostenloser Download für 32bit](#)

The installation program is started in the download folder.

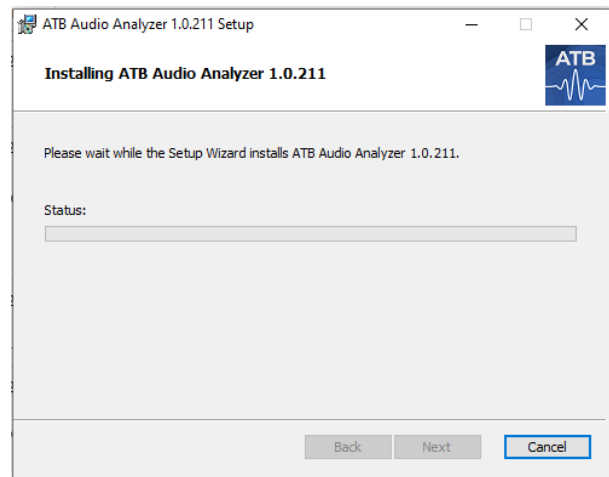
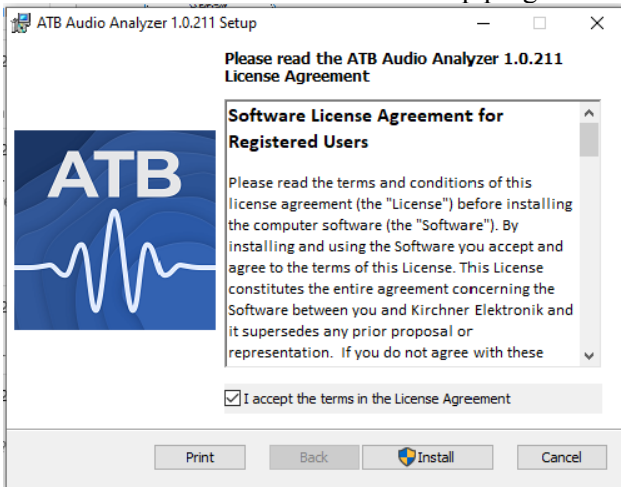
The following message may appear. This indicates an executing file.



In the following message, click on Further information.

Execute anyway to continue the installation.

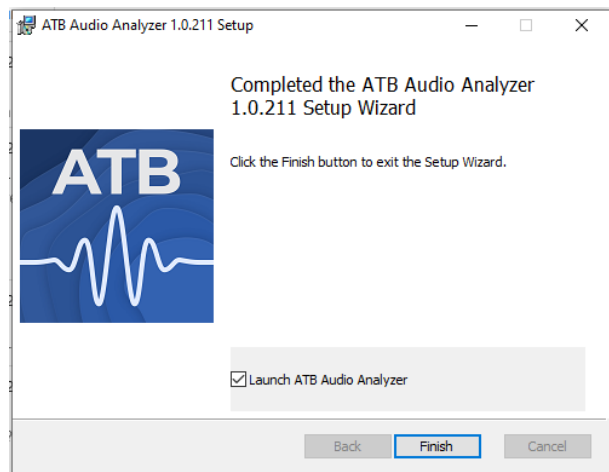
Now follow the instructions of the setup programme.



A menu appears with the following question:

Do you want to allow this app to make changes to your device made by this app?

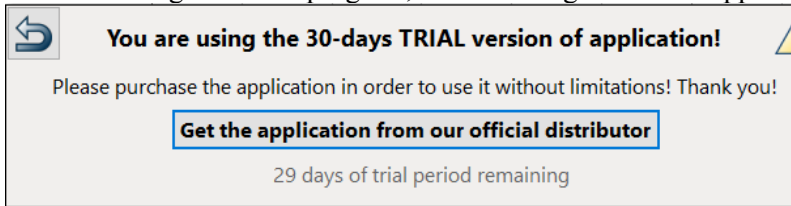
Confirm with "Yes".



**Kirchner elektronik**


## 2.2 ACTIVATION

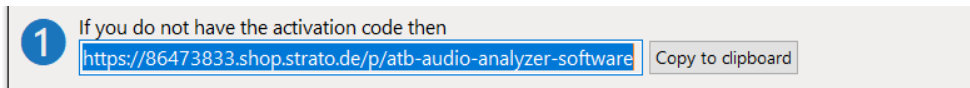
After installing the demo program, the following menu will appear when the program is launched:



When using the demo version, the menu is closed. The use of the demo version is indicated in the program



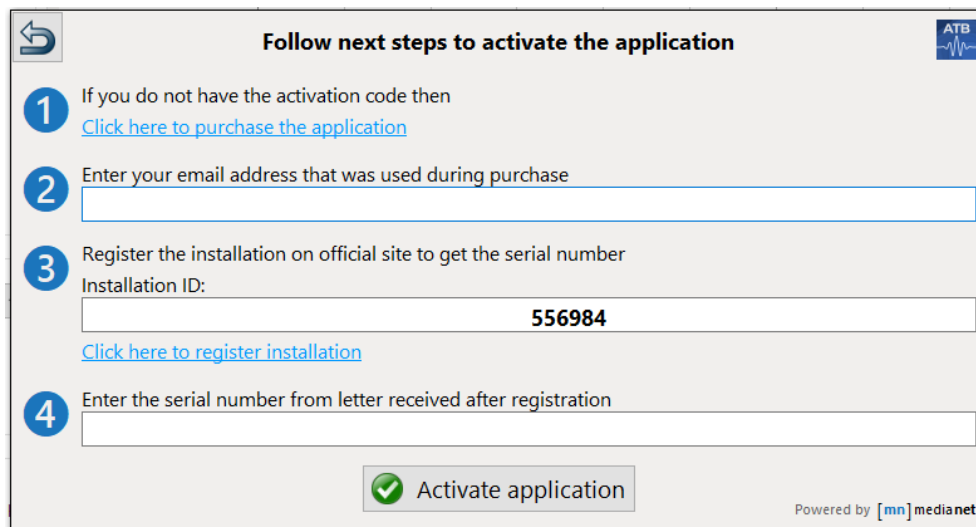
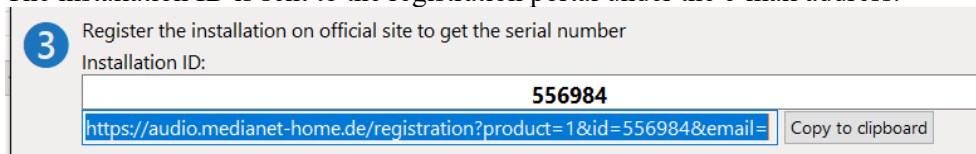
by the button  The button can also be used to start the purchase. In the menu select "Get the application from our official distributor".



The purchase is made in Kirchner elektronik Shop <https://86473833.shop.strato.de/>  
The purchase includes a USB stick with the program, manuals and other documents.  
An adapter for the calibration or the ATB USB measuring device can be ordered additionally.  
After purchase, Kirchner elektronik will forward your e-mail address to the registration portal.

2 The e-mail address is not to enter

3 The installation ID is sent to the registration portal under the e-mail address.



4 The serial number is entered in the menu.  
After the program is activated

**Kirchner elektronik**



## 2.3 EASY MODE MEASUREMENT

The program is very easy to use. The most important measurements only need to be started by the EASY Mode function for a professional result. The programming of the measurements has been rethought. Thus, the complicated functions and parameter inputs in the usual measurement programs have been replaced by mathematics.

### Program open



The button opens the programme.

The Navigation bar



The navigation bar is located at the top of the programme interface. This is designed in such a way that it is easy to use even with a Windows touch screen or tablet. The bar is used to call up the programmes, the setting, the reduction and the closing. The programmes are loaded, saved and labelled. The functions are described below.

Programme minimise



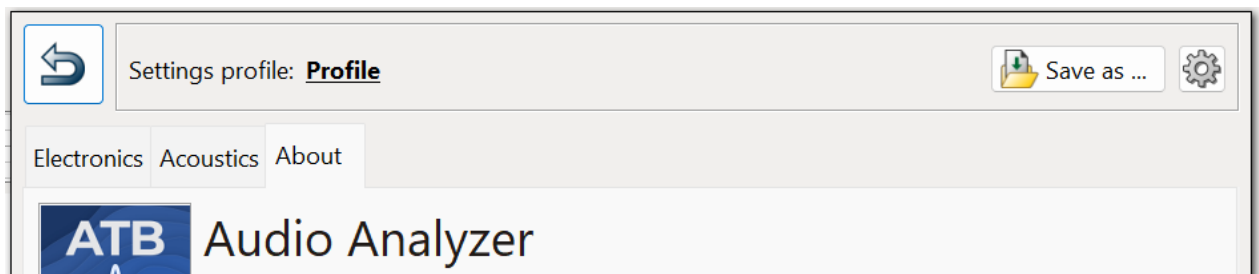
Program close



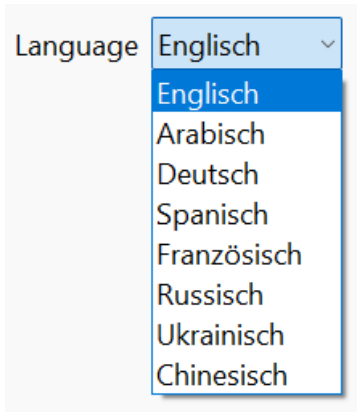
The storage location is also displayed there. When the programme is called up again, the parameters for the measurement and the measurement data are set.



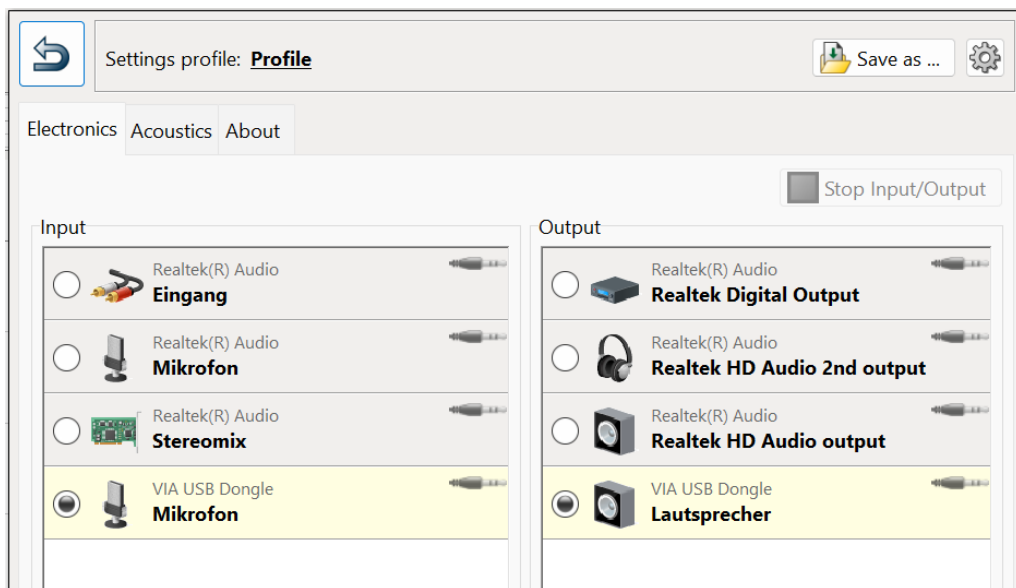
The button opens the Setting menu.




In the setting, the language is set under the About tab.



Next, the sound card is set in Setting under the Electronics tab.



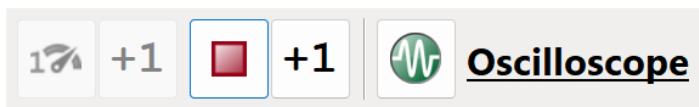
The USB sound card VIA is to be used.

For the first measurement the setting menu is left. The oscilloscope measurement appears, which can also be selected via the  button can be called.

A measuring microphone is connected to the sound card. This can also come from a surround amplifier with a calibration computer.

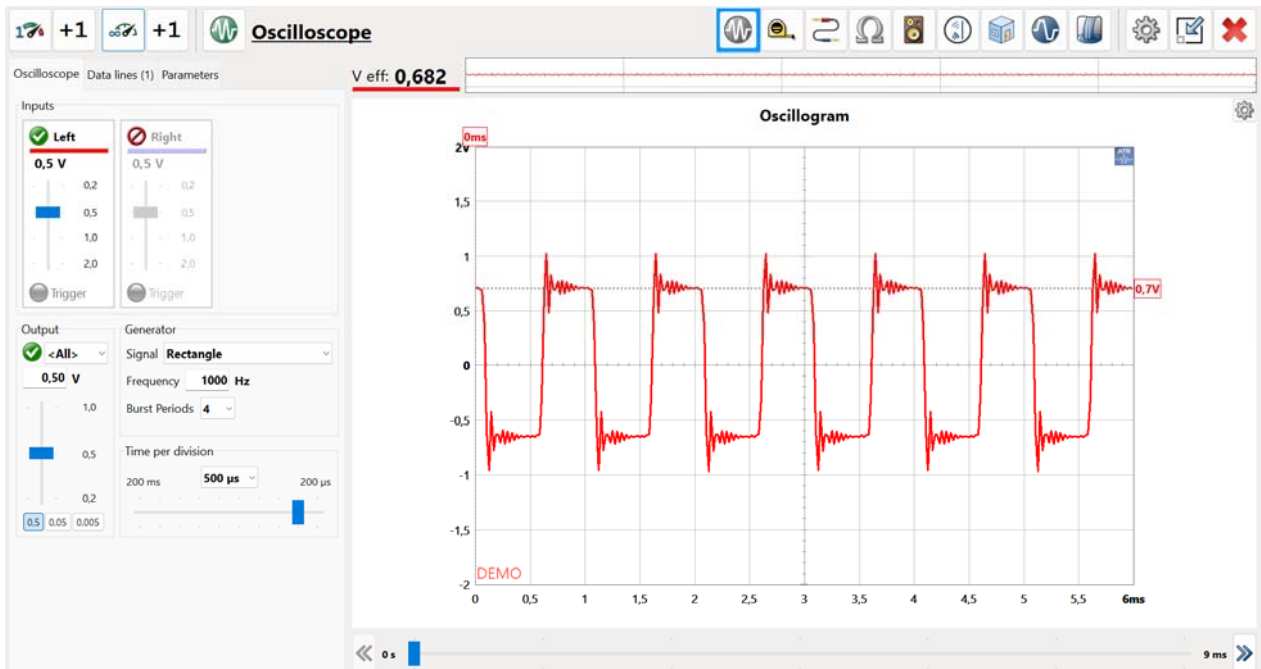
The amplifier is connected to the sound card to get the measurement signal. If this is complicated, e.g. with a car sound system, the signal can also come from the car test CD or from a stick with the .wav signal CDplus loaded from the website.

With the button for continuous measurement



the measurement is started and stopped.

The diagram shows the Rectangle signal.

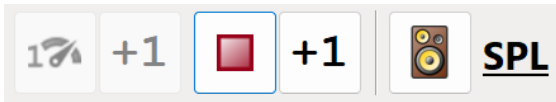


The oscilloscope measurement is not necessary for the following SPL measurement, but shows whether everything is connected correctly. The correct level is shown.

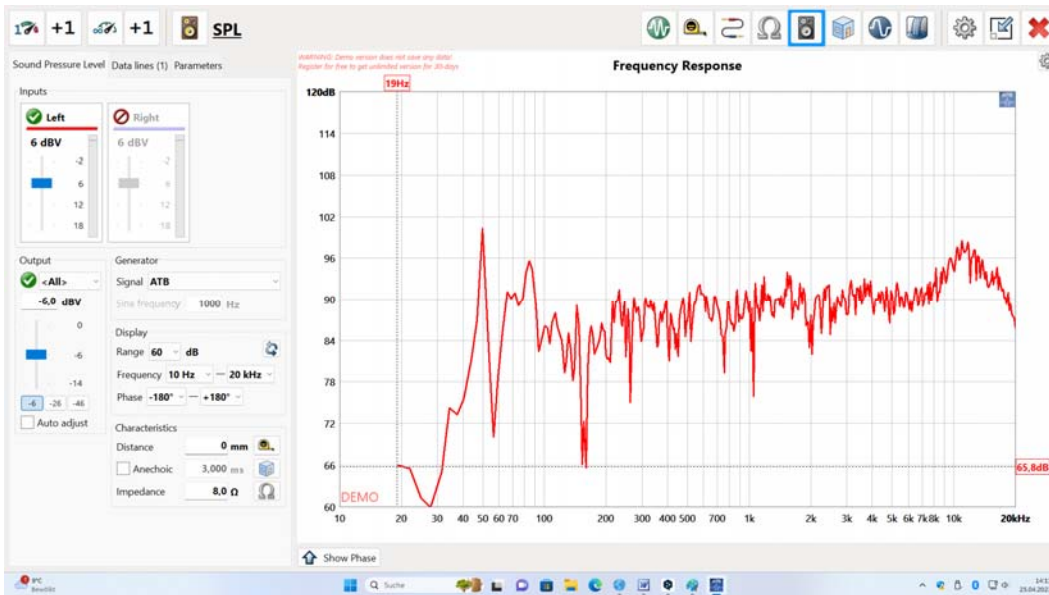


Next, the button  the SPL measurement is called.

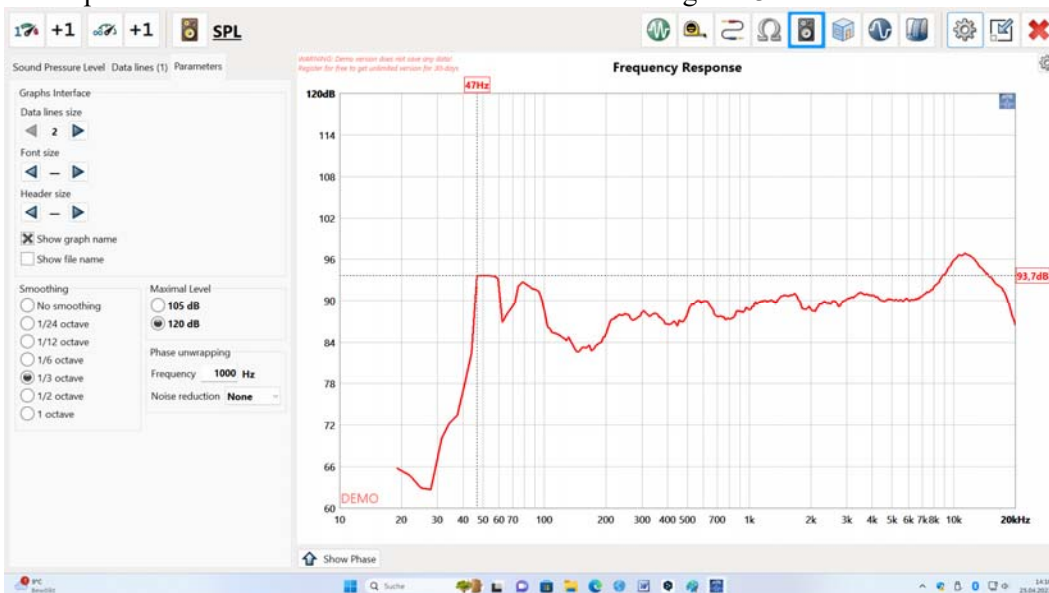
The measurement is started with the button



and stopped.



This picture of the frequency response is unusual. For a documentation the curve is smoothed. This is set on the parameter tab of the measurement. The usual setting is 1/3 octave




Kirchner elektronik


For the measurement of the acoustic phase, the transit time of the sound from the loudspeaker to the microphone must be compensated. This is also necessary for the waterfall measurement. For this purpose the program has the distance measurement.

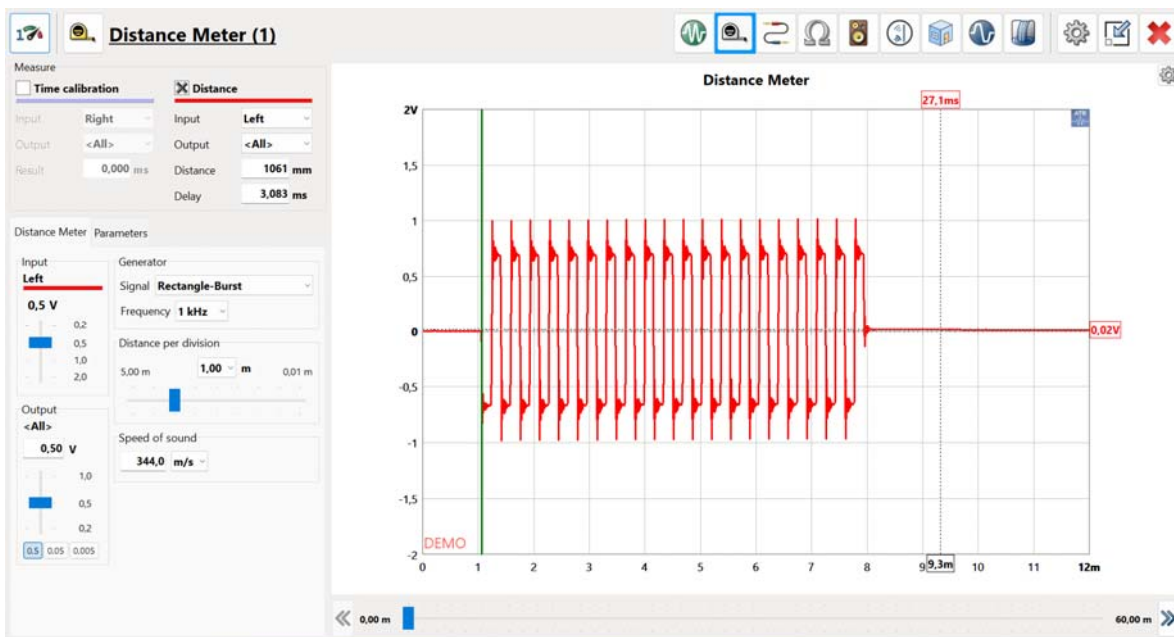
**For the distance measurement, the amplifier must be connected to the sound card.**



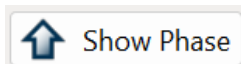
With the button  the distance measurement is opened.

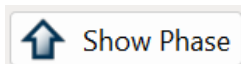


The time calibration is ticked and the measurement is started with . Continue continues the measurement.




The result is automatically transferred to the Oscilloscope, SPL and Waterfall programs. The real distance is not shown in DEMO MODE. The calibration is needed to measure the distance.



In the SPL program, the button  the amplitude frequency response and the phase frequency response are shown.



The measurement is performed as a single measurement with  started.



The tested loudspeaker is the OK<sup>2</sup>. The waveguide for the tweeter brings the mid-woofer and the tweeter to the same acoustic level. With the phase corrected crossover, you get the phase linear speaker. Since the mid and high tones reach the listener at the same time in the speaker, a natural and spatial reproduction is obtained.

The jump at 180Hz is a reflexion of the room.

With commercially available loudspeakers, the phase measurement shows quite a few jumps.

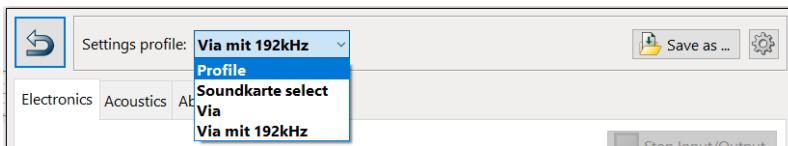
### 3. SETTING

#### 3.1 PROFILE

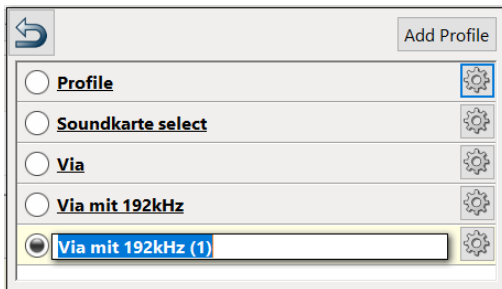
The measuring programme has convenient storage options. These make it possible to call up measurements that have already been carried out from the memory. The sound card and its calibration as well as the calibration of the microphone are saved in the profile. This makes it possible to start the measurement directly after starting the programme. When the sound card or microphone is changed, the corresponding profile is called up. The calibration does not have to be carried out again. Profiles with different settings for the calibration can also be saved. In the Setting menu, the profile is selected first. The profile determines the sound card and its setting and contains the calibration.

A profile can be the measurements in the car. In the car, a sound card with 48kHz and 16bit is selected, which measures the measurement signals of the car test CD. For the loudspeaker development, a profile with higher measurement accuracy is created. There is 96 kHz and 24bit chosen for the sound card. A profile can also be created for a specific microphone. Since the profile also contains the corresponding calibration, special measurements with special calibrations can also be created as a profile. The DSP, for example, can also be included in the calibration.

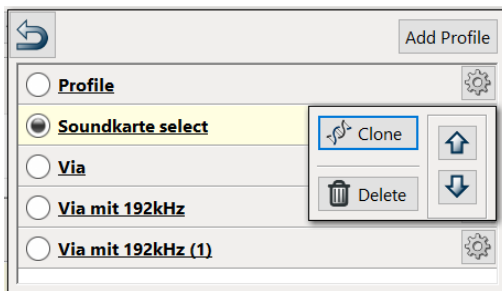
The number of profiles is not limited.



After calibration, save the profile with save profile, save at.



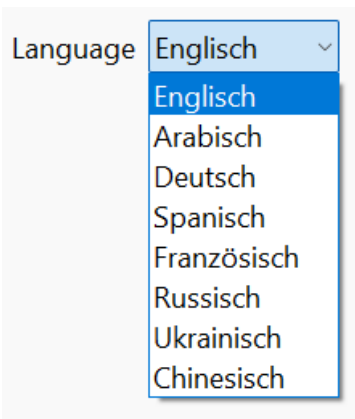
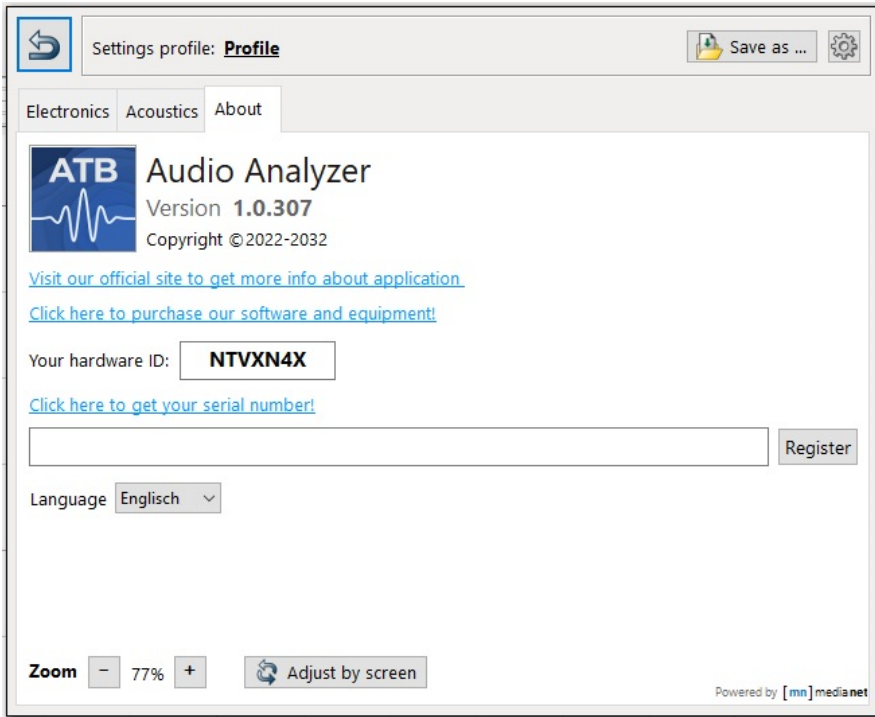
The profile is given a name in the menu. The profile is saved by closing the menu.



The profile is managed through this menu.

### 3.2 TAB ABOUT

In the Setting menu, the About tab is opened.



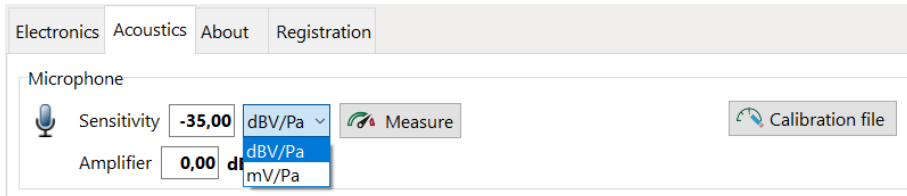
The language is selected here.



The size of the controls is set here.



### 3.3 TAB ACOUSTICS



In the Acoustics tab, the microphone is calibrated and a calibration file is loaded.

The calibration of the microphone requires the SPL measurement for the characteristic sound pressure, 1W/1m. The calibration determines the sensitivity of the microphone.



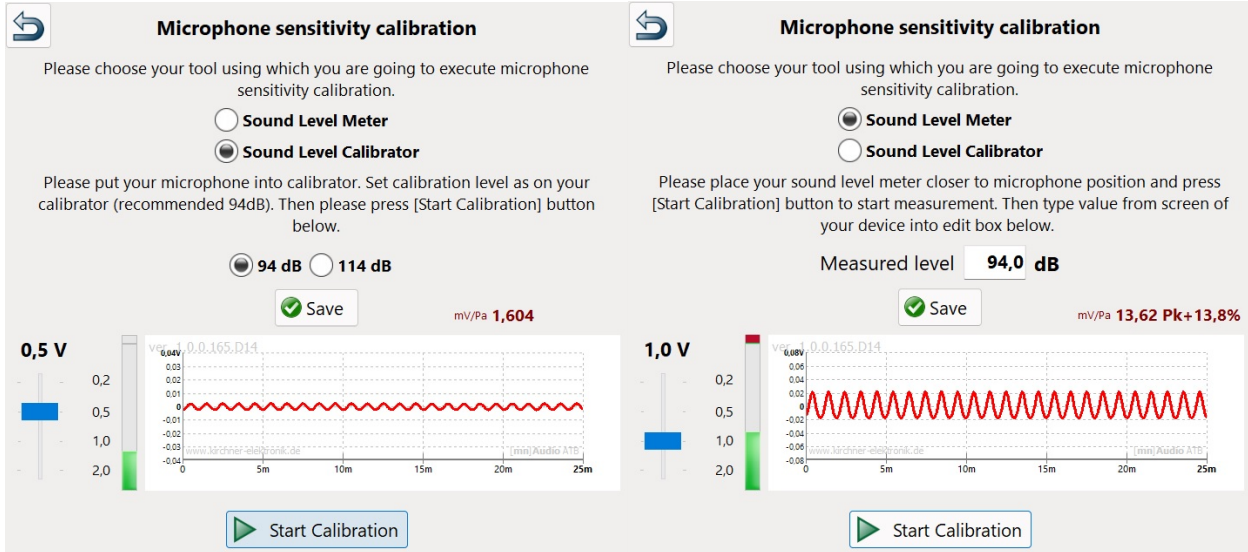
If the sensitivity is known, it is entered in the menu.

Depending on the manufacturer, it is given in sound pressure / pascal, dBV/Pa, or volts / pascal, mV/Pa.

If a microphone preamplifier is used for a sound pressure measurement, it is not taken into account in the calibration. Therefore, the gain can be entered in the menu under Amplifier.

If there is no sensitivity value for the microphone, or if this value is to be checked, the measuring programme offers two methods for calibrating the microphone.

Calibration with sound level meter



Calibration with calibrator

With these methods of calibration, the microphone preamplifier is taken into account for the display in the SPL measurement.

Attention:

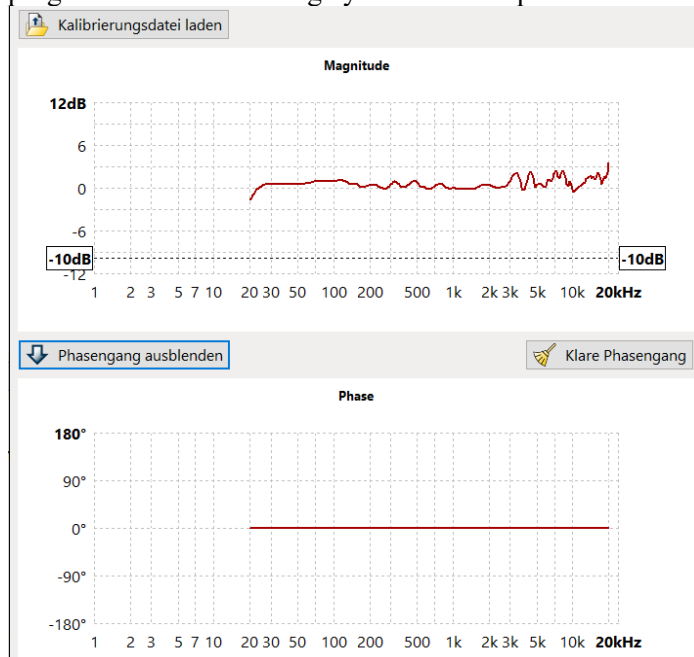
The microphone sensitivity, especially of microphone capsules, is measured differently by the manufacturer. Therefore check!

Calibration with sound level meter

**Kirchner elektronik**

## Calibration of the frequency response

Especially cheap microphones do not have a linear frequency response. Therefore, they are measured by the manufacturer and a correction file is created. The file can be loaded into the measuring programme and thus a largely linear sound pressure measurement can be carried out.



A calibration file is loaded in the menu.

Attention:

With this cheap microphone it is not useful to use the file. If there is no measurement error, the measurements are much smoother. No microphone has these jumps in the frequency response.

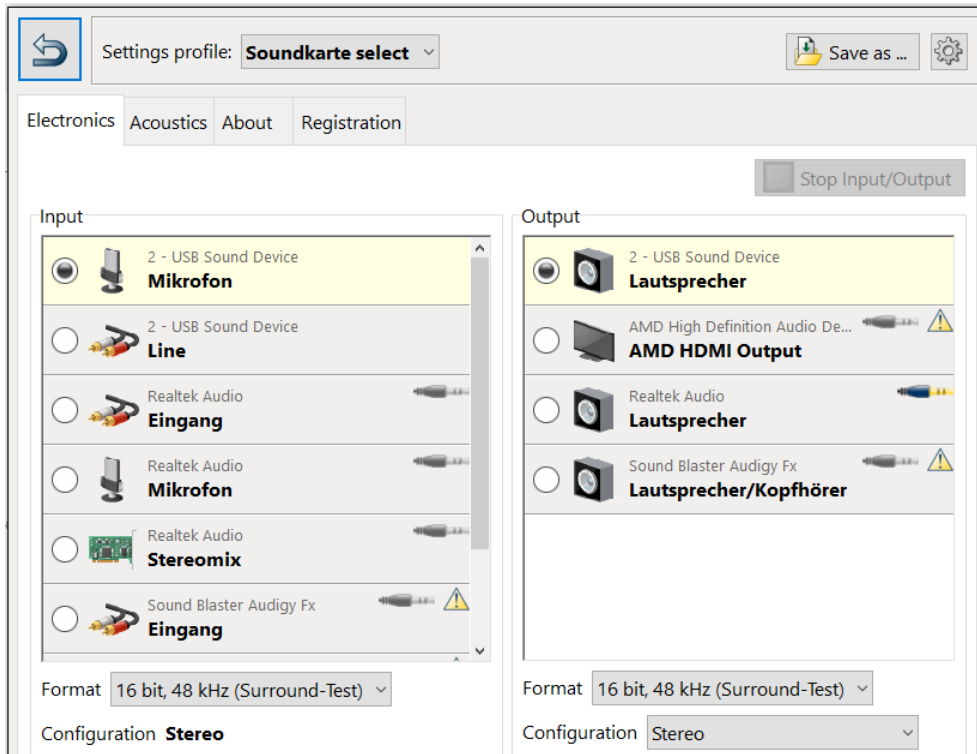
Proper measurement microphones do not need a calibration file.

The acoustic phase is rarely included in the calibration file.

The simplest measurement setup uses the Kirchner elektronik measurement microphone. This is connected directly to the microphone input of the sound card. The required supply voltage is provided by the socket. The microphone is calibrated. The calibration file can be downloaded from the website at download.

### 3.4 TAB ELECTRONICS

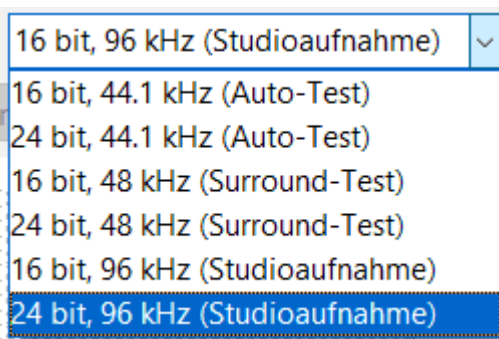
The electronics tab is opened in the setting menu.



The menu shows the available sound cards. The microphone input is selected for the input. This is used by the measuring programme. The microphone input has the full accuracy of the sound card.

If a profile is already available, it is selected and the sound card is activated.

Under Format, the resolution, bit, and the sample frequency, kHz, can be selected for input and output.



The menu shows the available settings. The measurements with the ATB signal are carried out with a sample rate of 48 kHz and a resolution of 24bit. The sample rate of 96 kHz does not extend the frequency response of the ATB signal, but is also not disadvantageous with regard to the phase measurement.

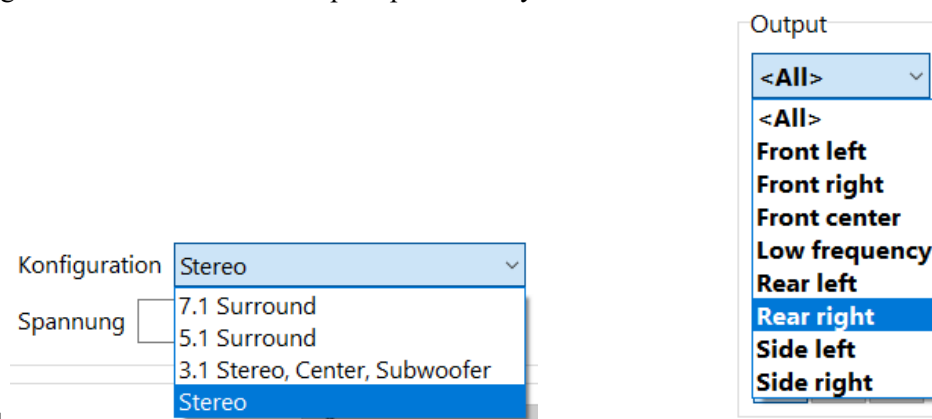
For the sine sweep, the sample rate of 96 kHz should be selected. Higher sample rates do not extend the frequency response, as the analogue amplifiers are only reasonably linear up to 30kHz.

For the waterfall measurement, a sample rate of 92kHz or 192kHz is advantageous for the representation of the high frequencies. The menu shows the technical data of the sound card. In addition to bit and kHz, the sensible setting of the corresponding measurement is also pointed out. The setting Studio recording is mainly necessary for the waterfall measurement. The programme tests whether the settings can be carried out by Windows. If the USB administration cannot carry out a setting, an error message is displayed. In this case, the resolution or sample frequency must be reduced.

### Setting the Surround System

The measuring programme offers the possibility to adjust the surround system. This is necessary because the measuring computers of the amplifiers work with algorithms that do not lead to the best sound. A big problem is the automatic adjustment of the subwoofer crossover. This only becomes correct through measurements with an external programme.

The measuring programme determines the outputs provided by the sound card. These are shown in the



configuration menu.

The configuration of the outputs is set according to the surround system. This setting is adopted in the measuring programme for the output controller, output selection.

#### Attention:

After changing the configuration, a new calibration is necessary.

The simplest measuring set-up uses the Kirchner elektronik measuring microphone. This is connected directly to the microphone input of the sound card. The required supply voltage is provided by the socket. However, a USB microphone can also be used.

To use all possibilities of the measuring programme, a sound card with two microphone inputs for the 2-channel measurement is recommended.

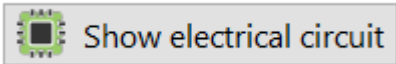
If the sound card has only one LINE input, a microphone preamplifier is necessary for the SPL measurement. The microphone amplifier is included in the calibration, whereby the supply voltage for the microphone must be switched off.

A sound card with 192kHz and 24bit has the maximum accuracy for the measurements.

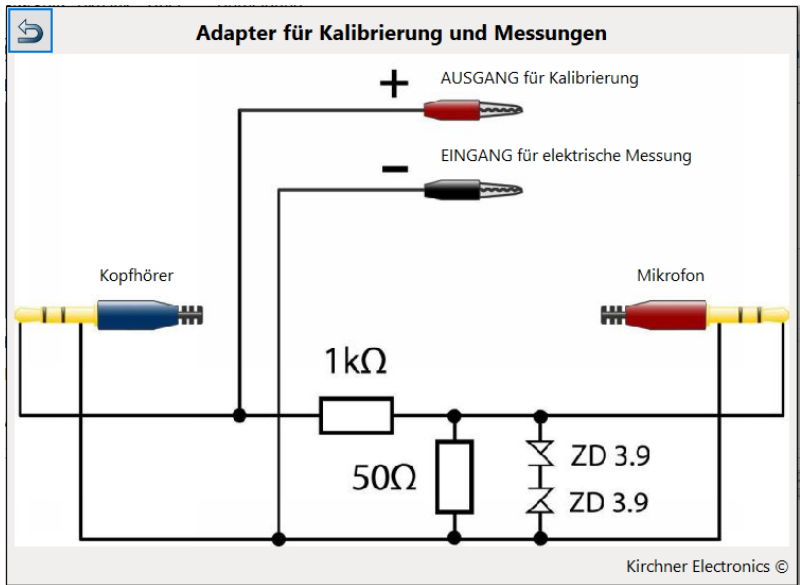
With the Kirchner Elektronik audio analyser, the USB device contains all the converters, amplifiers and switches required for the various measurements.

### 3.5 TEST-ADAPTER

The test adapter is necessary for calibration. This connects the headphone output of the sound card to the microphone input via a voltage divider.



With the button the circuit of the test adapter is shown



Simple version for a test adapter for calibration. A jack plug cable is cut and connected to the 1kΩ and 2x100Ω parallel resistors. The cable for the headphone output is connected with a hot wire. For the cable for the microphone input, both hot conductors are connected and connected. When measuring the output voltage, the ground conductor and the hot wire of the headphone output are connected to the multimeter.

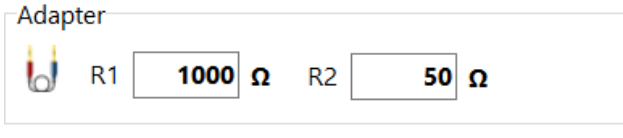


for the microphone.

The green plug is for the loudspeaker output and the blue

**Kirchner elektronik**

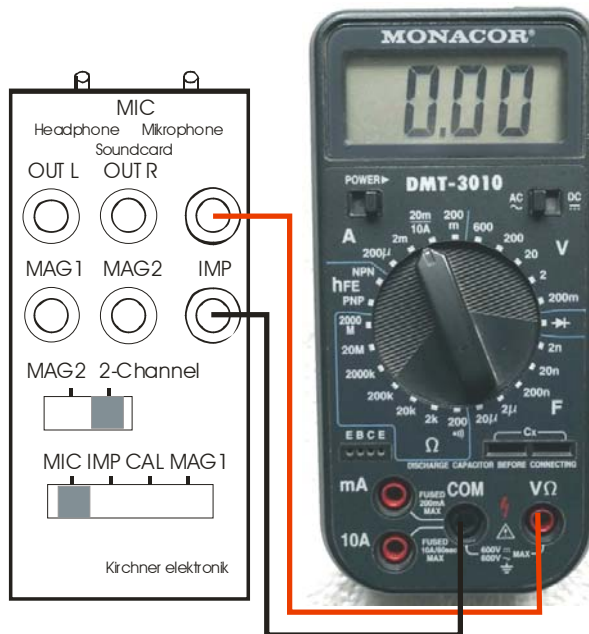
The adapter adapts the output voltage of the sound card to the sensitive microphone input with a voltage divider.



The values for R1 and R2 can be newly selected. However, the suggested values have proven themselves. ATB users can use the adapter of the ATB PC and ATB PC Pro. With the ATB PC Pro Test Adapter, 1 is selected. With the Kirchner elektronik audio analysers, 1 is selected for calibration. Different test adapters can be ordered in the Kirchner elektronik shop. The elaborate test adapters with various inputs and outputs as well as switches for selecting the measurement form an interface for easy performance of the measurements.

### Starting the calibration

The calibration process begins by measuring the voltage at the LINE or headphone output of the sound card. This is measured with a multimeter, whereby the AC measurement is set. If a 3.5mm jack cable is connected, the multimeter is connected according to the adapter circuit above. The output voltage of the sound card can be measured with an audio jack cinch cable at the cinch plug.



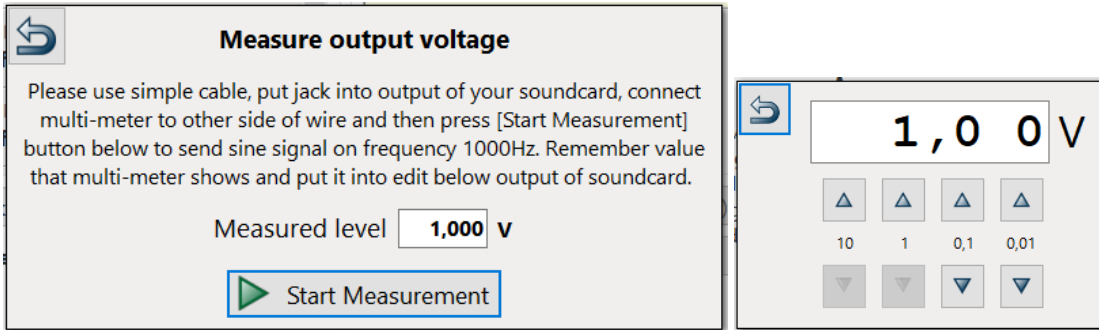
Measurement setup with the ATB Audio Analyzer test adapter



After activating the measurement with the Measure button, the menu appears in which the voltage is entered.

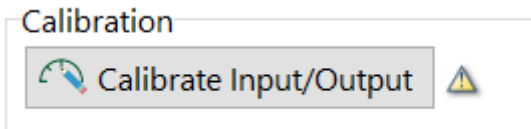
Carry out the measurement carefully. All level displays of the programme refer to this value.

**Kirchner elektronik**

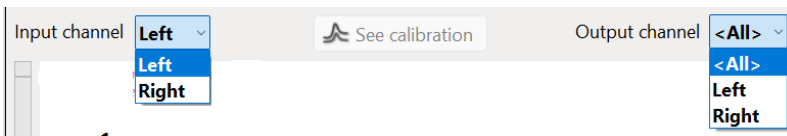


The next step is the input/output calibration.

The calibration linearises the frequency response, sets the accuracy for the voltage or level displays and determines the time response. Since the time response of a PC depends on many factors, a new calibration can be performed after a programme start. A new calibration is recommended for the time-dependent measurements of the oscilloscope, waterfall distance/delay.

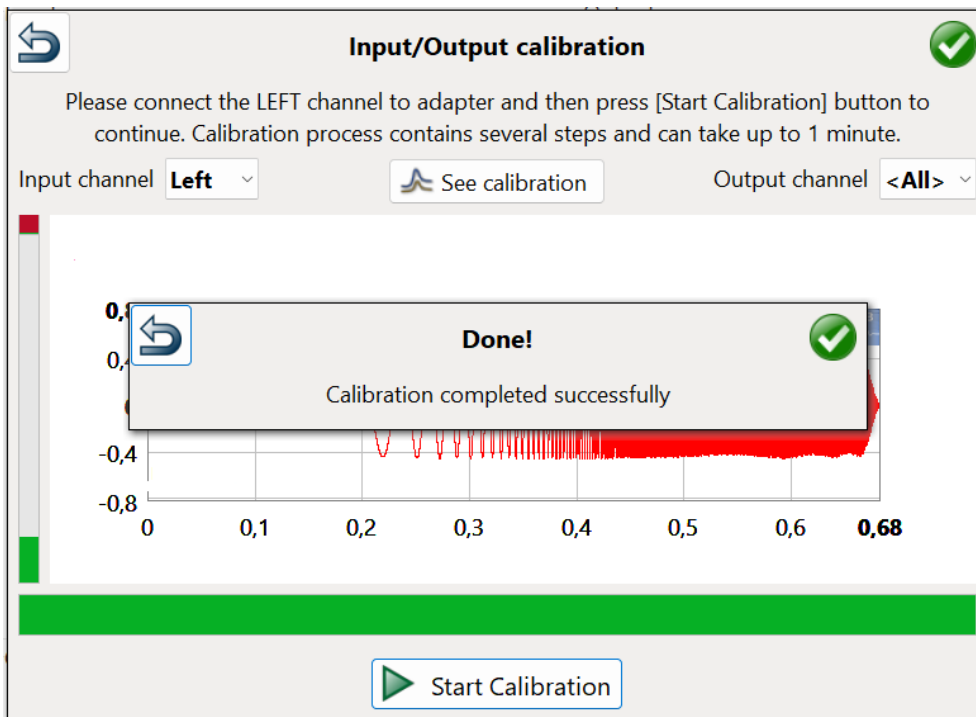


This is started with the Calibrate input/output button.

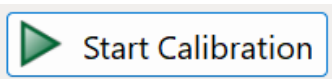


Before the measurement the input and output channel is selected.

Before the measurement the input and output channel is selected.



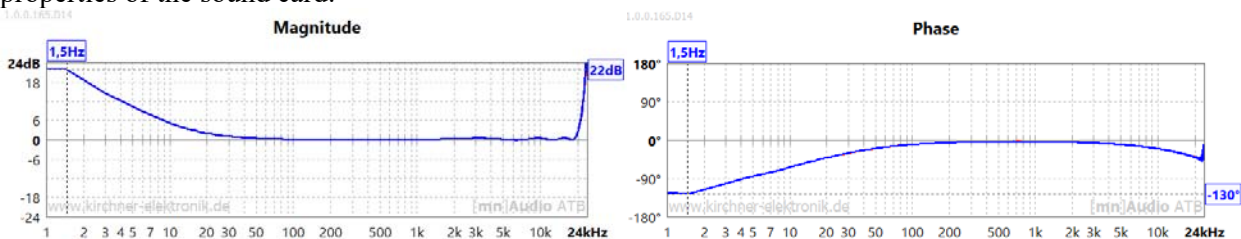
Kirchner elektronik



The process is started with Start Calibration. If an error message appears after the start, the selection of input and output is checked. Also the correct connection of the test adapter. With very few sound cards the assignment of the microphone input is exchanged.

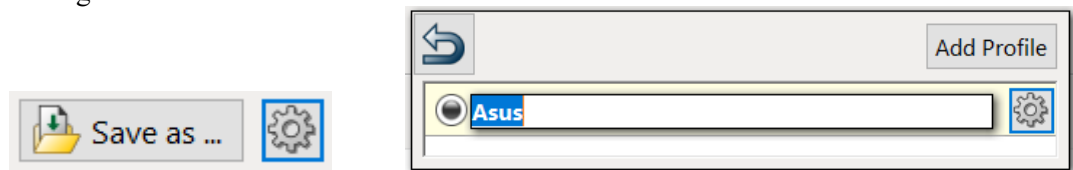
During the measurements, the settings for input and output as well as the frequency and time behaviour of the sound card are tested and correction files are created. An important function is also the test of the time behaviour of the operating system. The time behaviour depends to a certain extent on the configuration of the computer and the open programmes. Therefore, it can be useful to repeat the calibration when the open programmes are changed. Special computers or sound cards may also require calibration after each programme start.

If the above picture appears, the calibration has been carried out successfully. The button See Calibration shows the frequency and phase response of the sound card. These are used for correction in the following measurements. This is where the highest accuracy is achieved. The curves also give an indication of the properties of the sound card.



With Save profile the calibration is taken over into the setting profile. For different measurements, several profiles with different bits and kHz can be created for one sound card. These are then called up for the corresponding measurement

Saving the calibration



A calibration file is loaded in the menu.



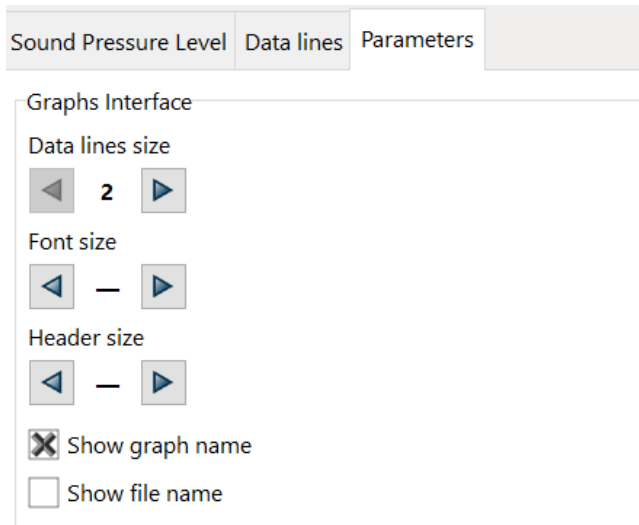
## 4. MANAGEMENT

### 4.1 LABELLING

The functions for the individual programs are identical.

The oscilloscope measurement is shown as an example.

Labelling and diagram name of the measurement are displayed for the measurements in the map.



tab.

The size of the labelling is set in the Parameters



By clicking on the font, the input field appears.



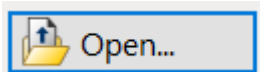
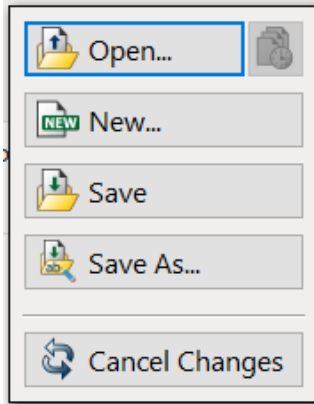
This is the name of the project. With this name the project is saved with one or many measurements.

The font is also entered in the measurement diagram at the same time. The font size is set in the parameter menu of the measurement. Here you can also choose whether the diagram name, Step response from correct, and the file name, Oscilloscope, should be displayed.

## 4.2 MEASUREMENT

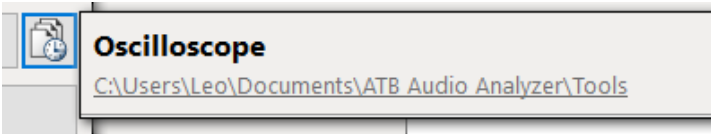


After clicking on the measurement button, the menu for loading and saving the measurement appears.

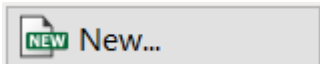


When pressed, a project with all measurements is loaded. The folder with the saved projects is opened in the Explorer.

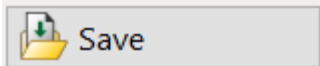
Oscilloscope.[atb]oscilloscope	30.05.2022 18:02	[ATB]OSCILLOSC...	283 KB
--------------------------------	------------------	-------------------	--------



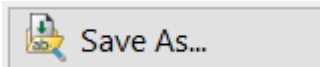
When the small button is pressed, the measurements that were saved when the programme was closed are shown.



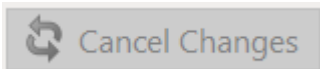
Start of a new project. When pressed, asks whether the current measurement should be saved. Afterwards the curves are deleted.



When pressed, all traces under data lines are saved in the previously used folder.



When pressed, the Explorer is opened to save all curves under data lines with new names in a folder to be selected.



E.g. deleted curves can be restored

### 4.3 MEASURING FUNCTIONS

The navigation bar also contains the measurement functions.

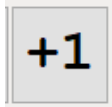


The measurements can be carried out as single measurements or continuous measurements, e.g. RTA for the SPL measurement.

The single measurements:



The button starts the single measurement. The existing measurements are deleted.

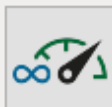


Starts a single measurement that is shown together with the previous measurements

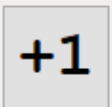


Image of the button during the ongoing measurement.

The continuous measurement:



Starts a continuous measurement. The existing measurements are deleted.



Starts a continuous measurement that is shown together with the previous measurements.



Image of the button during the measurement in progress. When pressed, the measurement is stopped, and after the measurement process has been completed, the measurement is shown.

For some measurements, the continuous measurement is not present and only the individual measurements are shown. The measurement distance only shows the button for starting the measurement process.

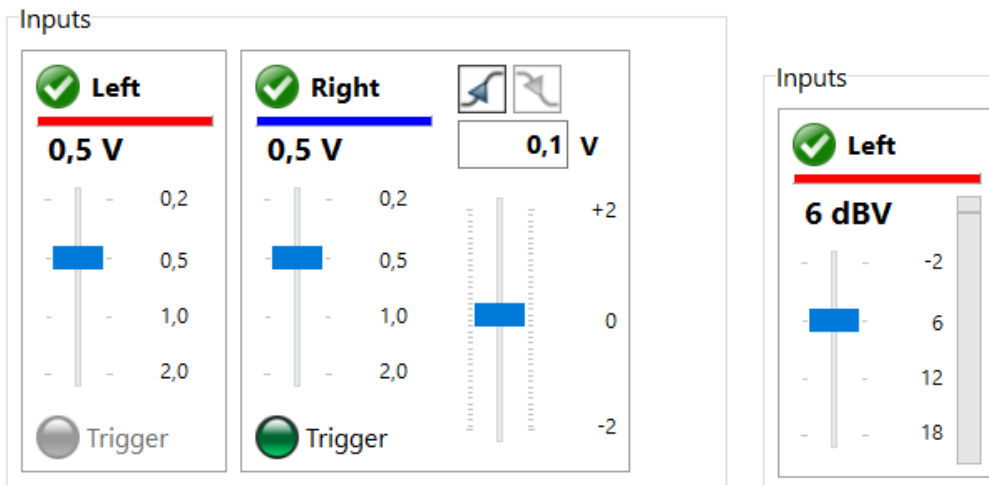
## 5. CONTROLS

### 5.1 CONTROLLER

The measuring ranges for the input voltage and the output voltage as well as times and time ranges are set with the sliders.

The setting is made by touching the scale or clicking the mouse. The slider can also be dragged by touching or clicking the mouse.

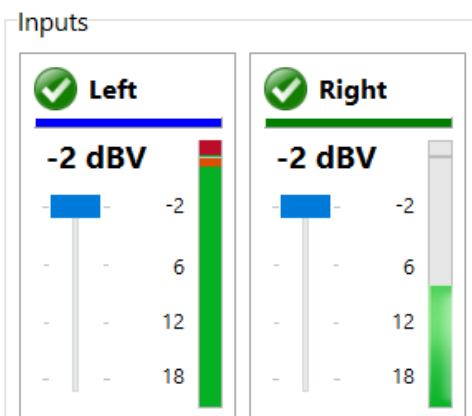
Controller for the measuring range of the input voltage.



The channel is selected in the menu above. Depending on the type of measurement, the setting is made in volts, voltage or dB for level. For the oscilloscope, a trigger can be called up.

Input voltage indicator, level indicator

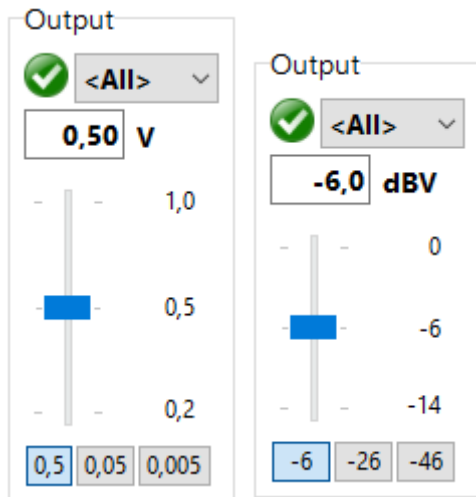
An important function in measurement technology is the display of the input voltage. If the voltage is too high, the input amplifier is overdriven, clipping, and the measurement is wrong. If the input voltage is too low, the measurement becomes inaccurate.



The green bar of the input voltage display, Level Indicator, shows the input voltage. If the bar turns red, the measurement is incorrect. If the bar is very small, the measurement is inaccurate.

**Kirchner elektronik**

Control for output voltage, level



Controller for the output voltage

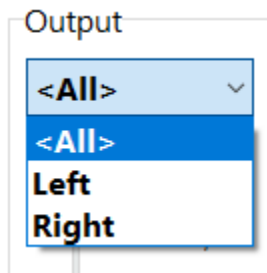
According to the measurement, the output voltage is set in volts or dB.

Attention: The highest value in the slider does not correspond to the maximum level. The maximum level is + 2dB to the output voltage value measured in the setting menu. For the volt display, the maximum value is 1.26 x the voltage measured in the setting menu.



The output voltage can also be entered as a numerical value.

The ranges for the voltage are automatically selected according to the calibration. No values are accepted in the menu for the setting that exceeds the maximum voltage.



In the upper section, the channel for the output voltage is selected.

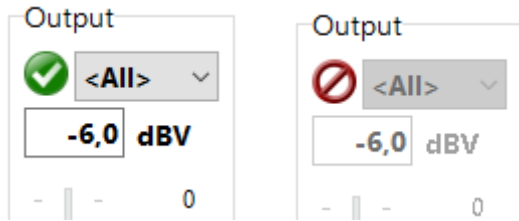


The buttons below are used to select a decimal range for the value set on the controller.

For the SPL measurement  **Autoanpass.** an automatic setting for the standardised measurement can be made.

### Measurements with signals from external programmes.

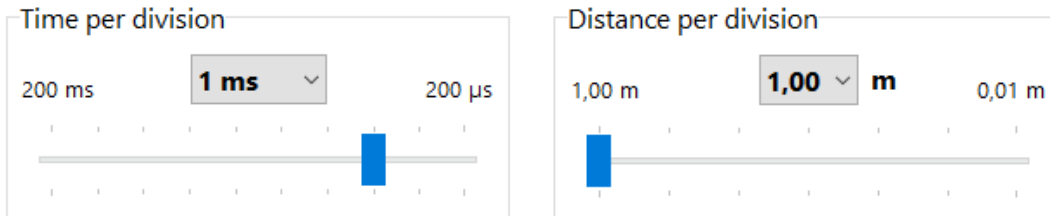
For measurements that do not require time calibration, the measurement signals can also come from an external programme, e.g. the media player. By switching off the output by the programme, the output of the sound card can be used by the external programmes. The sound card is then set in the Windows administration.



Switching off the sound card output for the ATB

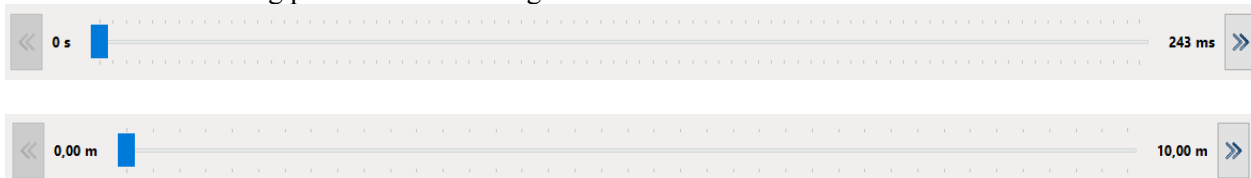
One application is the measurement with weighted frequency responses. For this purpose, the ATB .wav file is loaded from the website into an audio programme, AVS Audio Editor, and the frequency response is adjusted according to the DIN for the volume measurement of headphones. The weighted ATB signal can be played back by the AVR Audio Editor after the output of the SPL ATB measurement has been switched off.

#### Controller for time base and distance



This control sets the time base for the oscilloscope. For distance measurement, the distance per division is set.

#### Controller for a starting point in the time diagram



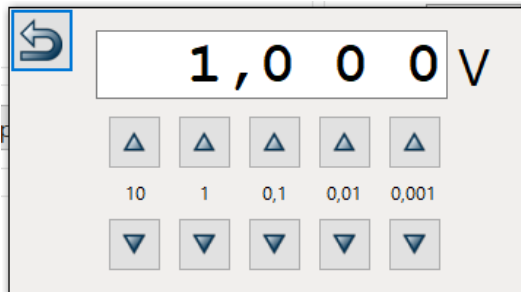
With the slider, the beginning of the curve can be selected for the oscilloscope and the distance measurement in the diagram. The curve is shifted according to time or distance.

## 5.2 INPUT WINDOW

Numerical input

Result	<input type="text" value="19,609"/> ms	Distance	<input type="text" value="0"/> mm
		Delay	<input type="text" value="0,000"/> ms

In the light fields, the input of a number is opened after touching the area or clicking the mouse.

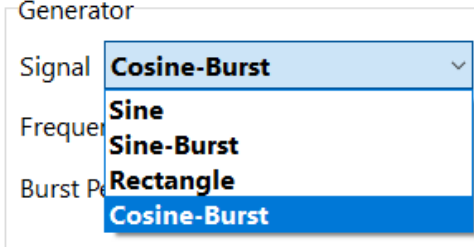


The image shows a numerical input window. At the top left is a blue square button with a white return arrow. To its right is a white text field containing the number '1,000' followed by a 'V' unit. Below the text field are two rows of five arrow keys each. The top row has five upward-pointing triangles, and the bottom row has five downward-pointing triangles. Below each arrow key is a numerical value: 10, 1, 0,1, 0,01, and 0,001.

The entry is made with the arrow keys.  After the input, the button is used to return.

Preset outputs

Generator	<input type="text" value="Sine"/>
Signal	<input type="text" value="Sine"/>

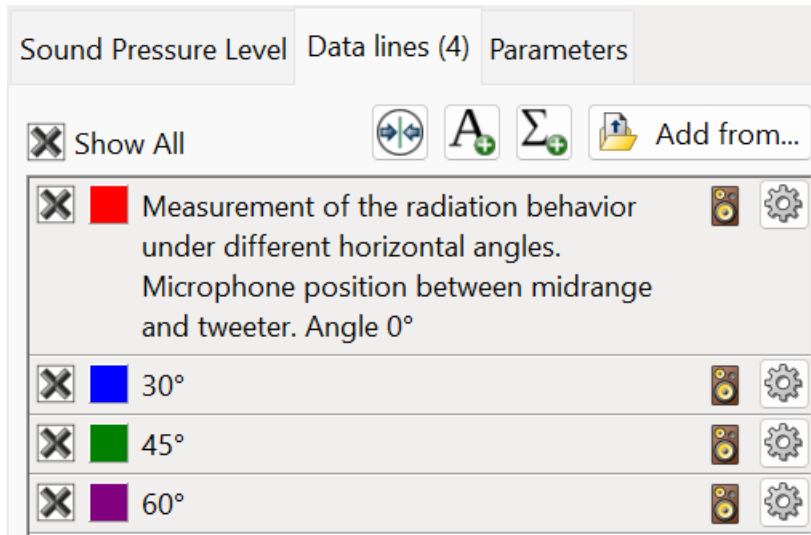


The image shows a 'Generator' dropdown menu. The menu is open, showing a list of options: 'Cosine-Burst', 'Sine', 'Sine-Burst', 'Rectangle', and 'Cosine-Burst'. The 'Cosine-Burst' option at the bottom is highlighted in blue. The menu is positioned over a 'Generator' dropdown menu in a 'Preset outputs' section, which currently shows 'Sine' selected.

In the coloured fields, predefined values, functions and settings can be set after touching or clicking the mouse.

### 5.3 DATA LINES

Each measurement has the Data Line tab.

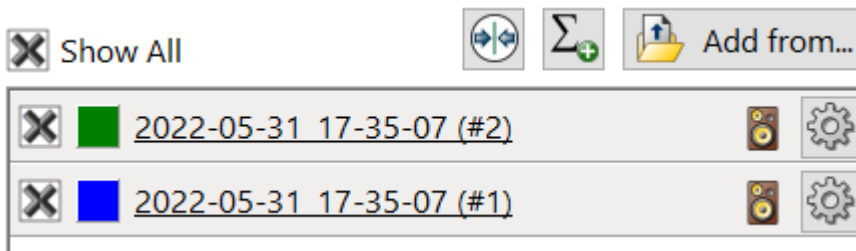


In the menu, the individual measurements are shown and managed. The measurement curves are automatically labelled with date and time. (#1) identifies the left channel and (#2) the right channel.

#### Labelling the measurement curves in the diagram



By touching the button or clicking the mouse, the entry for the measurement curve appears in colour. In the diagram, the measurement curve is marked by a stronger curve. Display of the measurement curve in the diagram



By setting the cross in the left box, the measurement curve is displayed in the diagram.

With  Zeige alles all measurement curves can be made invisible or visible in the diagram with one touch of the button or mouse click.



## Colour of the measurement curve

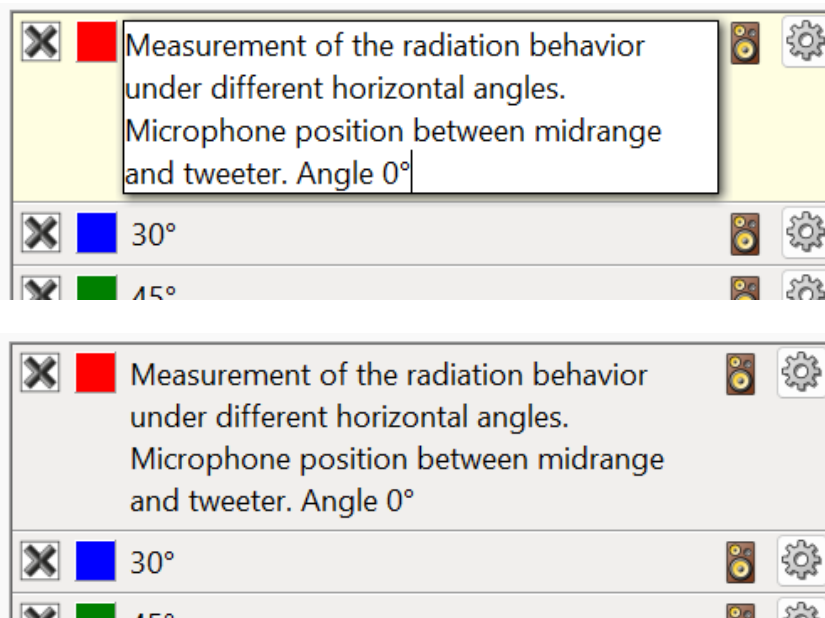
The colour for the trace is determined automatically.



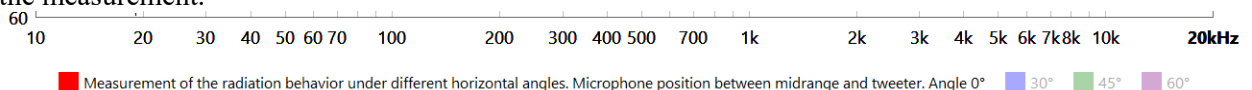
After touching the coloured left button or clicking the mouse, a colour palette appears. Here you can select a colour for the measurement curve.

## Labelling the measurement curve

After an entry for the measurement curve has been marked, a field for editing the name is opened by touching the font or clicking the mouse. The size of the text window is automatically adjusted.



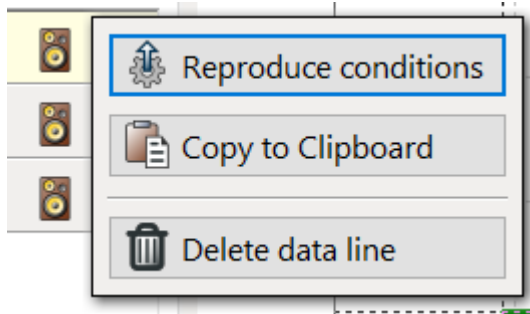
When "Legend" is activated on the parameter page, the text for the individual curves is displayed under the measurement.



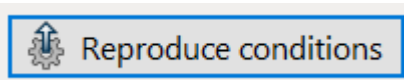
Kirchner elektronik

## Reproduce, Copy to Clipboard, Delete

After pressing the button  the following menu opens

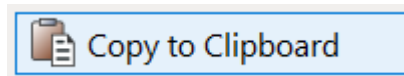


### Reproduce conditions

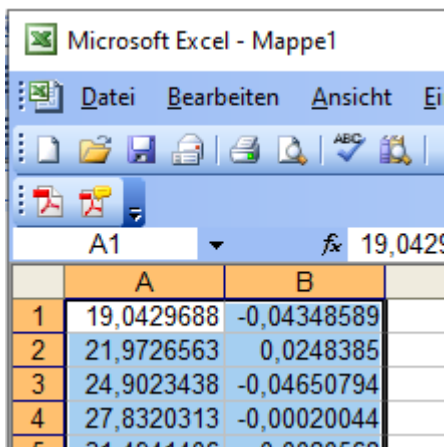


The function marks the curve.

### Copy to clipboard

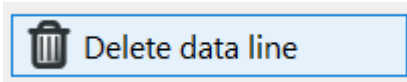


The button copies the data as an ASCII file to the clipboard. From the clipboard, the data is pasted into an editor or Excel document. There the data is processed for special presentations or evaluations.



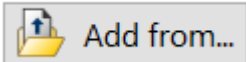
	A	B
1	19,0429688	-0,04348589
2	21,9726563	0,0248385
3	24,9023438	-0,04650794
4	27,8320313	-0,00020044
5	31,1044106	0,0000568

## Delete data Line

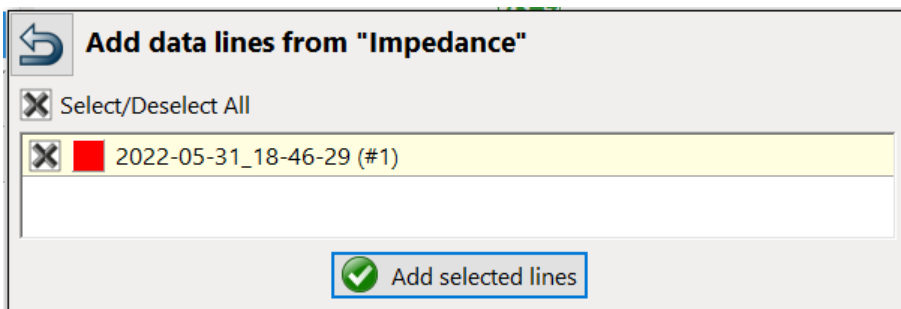


The measurement curves are deleted from the diagram. The deleted curves are not saved, but they can be deleted by

## Loading measurements



This button is used to add measurements from other projects. After pressing it, the folder for the measurements is called up in the Explorer. The corresponding project is opened there.



In this menu, the required measurements can be marked and loaded.

## 5.4 DIAGRAM HEADER

The diagram header is selected for the individual measuring menus on the "Parameters" card.

Sound Pressure Level | Data lines (4) | Parameters

Description

Kirchner elektronik Laboratory

Graphs Interface

Data lines size

◀ 2 ▶

Font size

◀ — ▶

Header size

◀ — ▶

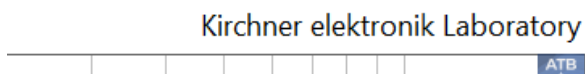
Show graph name

Show file name

Show description

Show legend

For Description, a text is entered that is placed directly above the diagram.



The name of the measurement is activated with Show file name. This is specified by the program.

### **(Frequency Response)**

The name of the file is also the name of the project under which the measurements are saved. It is activated with Show file name.

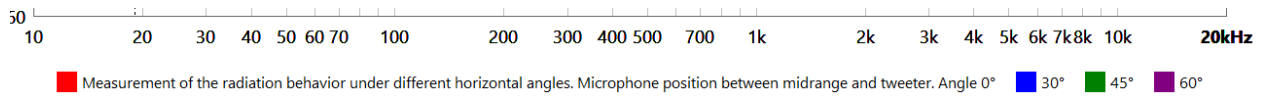


The name is entered at the top of the program.

**Kirchner elektronik**

## 5.5 DIAGRAM FOOTER

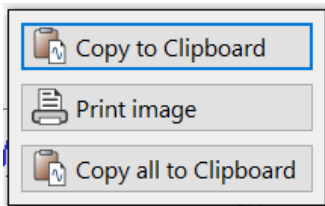
The footer shows the individual measurements and their notes.



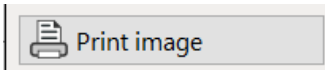
## 5.6 DIAGRAM MANAGEMENT



The button at the top right of the diagram calls up the menu for diagram management.



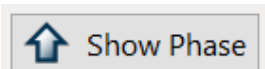
Copy to clipboard copies the diagram to the clipboard.



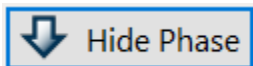
With print image the diagram is printed.

### Phase

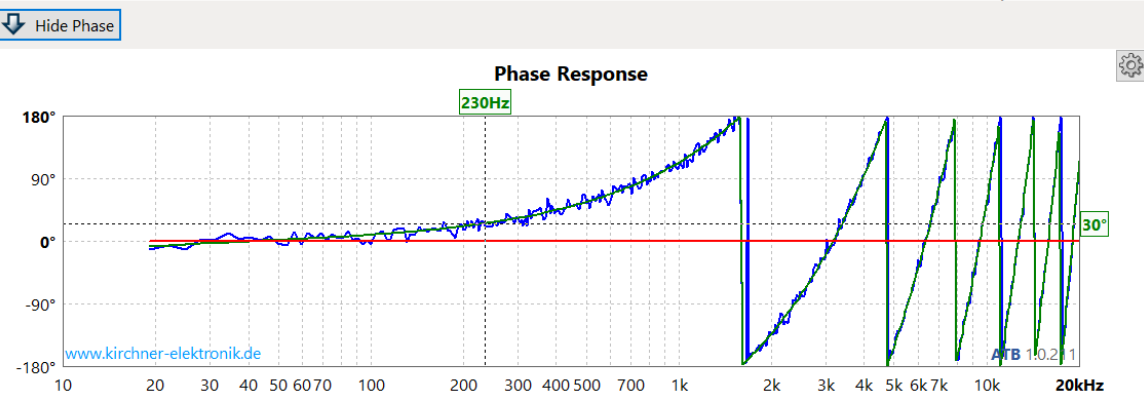
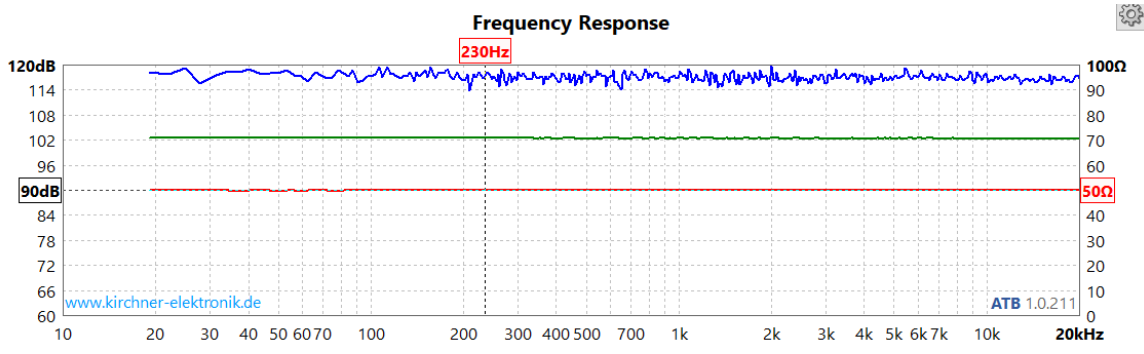
Bei der Messungen Magnitude, Impedanz und SPL wird neben den Amplituden und dem Betrag der Impedanz auch die Phase gemessen.



This button displays the phase.



This button hides the phase



**Scaling**

The scaling is set in the menu of the measuring programme.

**Y-axis**

For the Y-axis, there is the maximum value and the range of values. The maximum range is given by the value selected in the input controller for the oscilloscope, distance, magnitude and THD. This value is automatically set by the programme. For the SPL measurement with standardised diagram, two maximum ranges can be set on the parameter

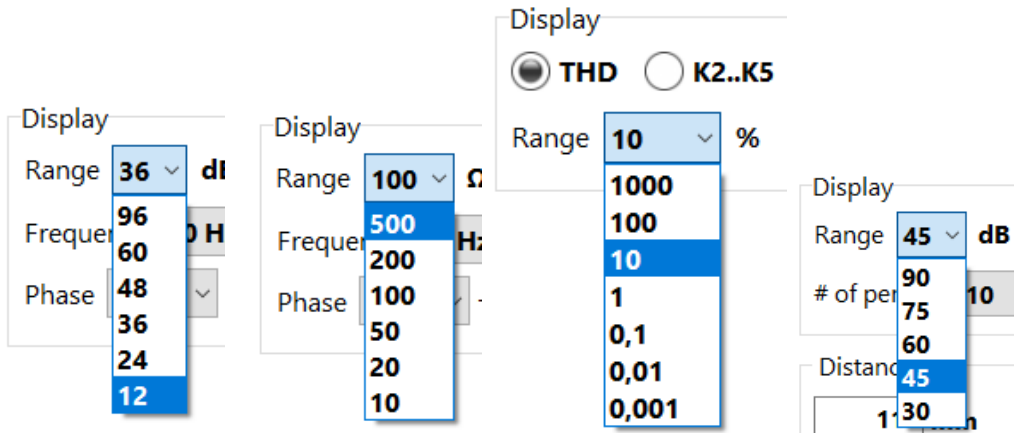
Maximal Level

105 dB

120 dB

tab.

For the magnitude Measurement at the Magnitude, Impedance, Distortion and Waterfall tab



### Y-axis, phase



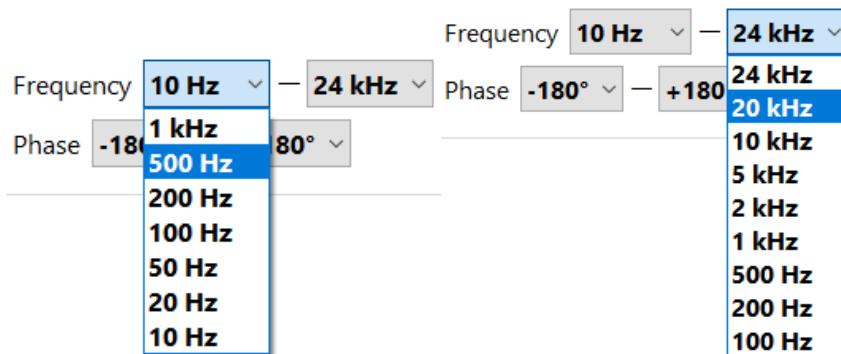
The diagram can be set so that the phase response can be displayed without jumps, unwrapped.

### X-axis

The x-axis shows the time or frequency range for Magnitude, Impedance, SPL, Distortion and Waterfall measurement.

The time axis in the Oscilloscope and Distance starts at 0 and ends at the time that fits into the diagram in the range corresponding to the resolution.

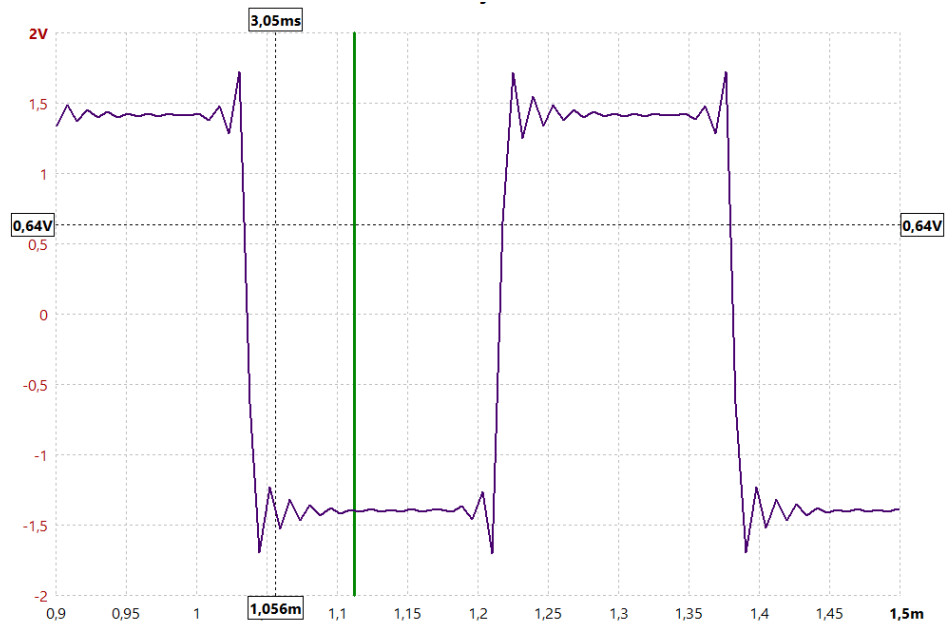
For the frequency axis, a start and end value is set in the measurement menu.



The picture shows the setting at Magnitude.

### Cursor

The cursor is used to read out measurement data in the diagram.



By touching the diagram area or moving the mouse over the area, the values for the selected position are displayed on the axes. The values have the unit of the axes.

For the distance measurement, two values are displayed for the X-axis, the distance in metres and the delay time in ms.

### Magnifier, Zoom

Swiping or guiding the mouse while holding down the left button shifts the value range of the axes.

Shifting for the X-axis.

For the time measurements, oscilloscope and distance measurement, the range for the time is shifted. This serves as a magnifying glass function. With a high resolution, very short time per division, the beginning of a signal can be shown.

For the frequency response measurements, SPL, impedance and THD, the frequency range is shifted. If the range for the frequencies is small, it is shifted over the range of the measured frequencies. This is possible because measurements are always taken over the frequency range of 20Hz - 24 kHz in the ATB measurement. With the sine sweep the range is from 10Hz - 24 kHz.

Shifting with the Y-axis



For the frequency response measurements, magnitude, SPL, impedance and THD, the range for the dB is shifted. This serves as a magnifying glass. With a small range for the dB values, the value range can be shifted so that the curve comes into the display range.

## 5.7 VOLTMETER

The voltmeter is shown in the oscilloscope menu. They are real RMS values.



Behind the meter, a small oscilloscope shows the signal shape of the voltage.

## 5.8 GENERATOR

The generator produces the measurement signals. The ATB Audio Analyzer generates signals adapted to the corresponding measurement. The signals are selected in the menu of the individual measurement.

For the signals for the frequency response measurements, you can choose between the ATB signal and the sine sweep. Each developer will prefer one of the signals.

The sine sweep is also used with the Klippel measurement system. Our developers have invested a lot of energy in the development of the sine sweep measurements. The result is that the measurement achieves the precision of the ATB measurement.

For the sine sweep measurement, a sampling rate of 96 kHz should be selected. This makes the measurements more accurate than in programmes that only operate at 48 kHz.

The MLS signal showed significant errors in the measurements compared to the other two signals. Therefore, it is not supported.

## 5.9 THE ATB SIGNAL

The ATB or M-PN (Metzner-Periodic-Noise) signal used in frequency response measurement is a deterministic noise. Since the signal is periodic, a very precise measurement is made possible. The mathematical evaluation of the measured signal becomes more precise. Measurements are also possible where the measurement signal is generated by another device. For measurements in a car, the signal can be played from the CD player or, in the case of a surround system, from the DVD player. Due to the 4-fold oversampling function, it corresponds to an analogue signal. One consideration in the development of the signal was the adaptation of the measurement technique to the later function of the tested device. A loudspeaker is supposed to transmit music and speech. Accordingly, the power handling of the loudspeaker is also defined for the frequency ranges. According to DIN, the power at 100% total output is distributed as follows:

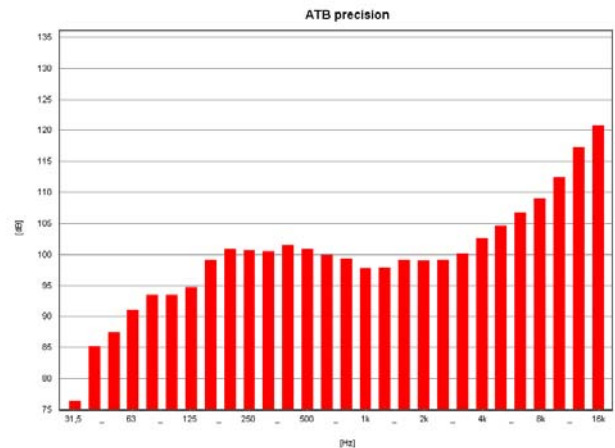
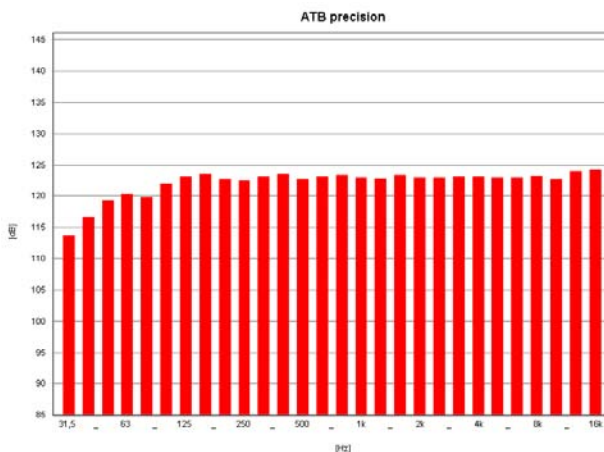
Low frequency range from 40Hz - 600Hz 62%.

Midrange from 600Hz - 4kHz 30%

High frequency from 4kHz - 20kHz 8%

M-PN

MLS



The pink noise signal here is matched to the music because of the even distribution of energy over the frequency response. With the MLS, Maximum Length Sequence it is exactly the opposite.

The pictures show the analyzer measurements of PPN and MLS signal. Both signals are deterministic noise, a mixture of frequencies. The PPN signal shows a pink noise. Practically all third octave bars have the same amplitude. The drop in the low frequency range is negligible for the measurement. The MLS signal corresponds more to white noise. This can also be heard well in the measurement. The high frequencies have very high amplitude and the low frequencies are contained in the signal with -45dB. In contrast to the third octave analysis, the MLS signal appears after the measurement with a straight frequency response due to the correlation. A correlation has the following function:

The loudspeaker is driven with the MLS signal with the frequency distribution shown above. If the loudspeaker has e.g. a linear frequency response, the same signal is recorded by the measuring microphone. In the measuring device it is converted into a digital signal. This signal and the MLS signal are available in digital form in the computer. During correlation, the two signals are compared. The measurement result, the frequency response, consists of the representation of the deviations. If both signals are equal, the case of the linear loudspeaker, the result is a straight line. If the loudspeaker does not transmit the low frequency range as well, the difference between the measured signal and the output signal is shown as a drop in the frequency response.

**Kirchner elektronik**

The following will show that the MLS signal is not suitable for this measurement. The loudspeaker is driven with the signal according to the energy distribution shown in the third octave analyser. The energy distribution of the MLS is exactly opposite to the music signal; a lot of energy in the treble range and almost no energy in the low frequency range. The consequences of this are:

The very high energy of the high frequencies overdrives the tweeter, so that part of the measured frequency response consists of dynamic compression and distortion. A frequency response corresponding to music reproduction cannot be measured in this way. 3.

Due to the very small signals in the low frequency range, an accurate and reproducible measurement is almost impossible. It is also pointed out in the case of measuring systems with MLS that an exact result is only achieved after approx. 10 averaged measurements (with adaptive windows).

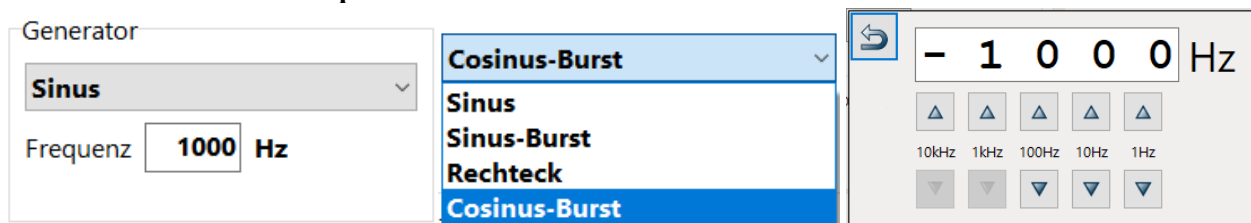
The M-PN signal has a uniform energy distribution. It does not overdrive the tweeter and has sufficient signal amplitude in the low frequency range. The measurements are reliable on their own (even without averaging).

## Operation

The generator is automatically started and stopped during measurements.

Due to the continuous measurement, the generator can also be used as a signal source.

## Generator in the oscilloscope



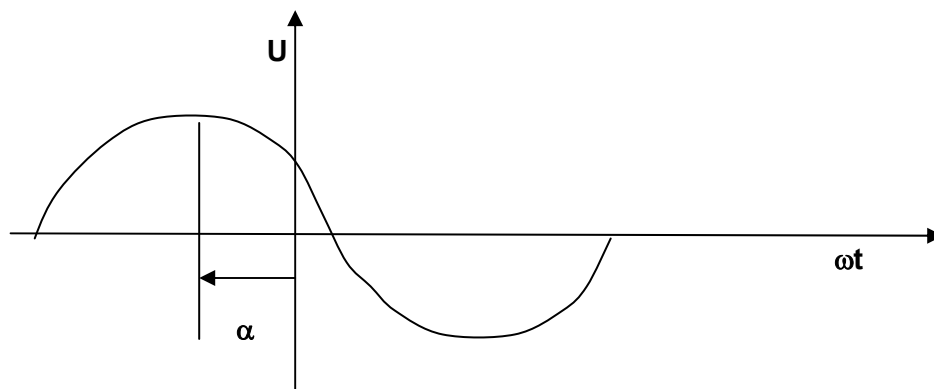
The signal shape, frequency and level are set for the output.

## 6. PHASE MEASUREMENT

### 6.1 BASICS

The phase describes the time allocation of sinusoidal processes such as mechanical oscillations, alternating current, radio waves and sound waves.

The oscillations are measured with the oscilloscope. The oscillogram shows the time course of the oscillation, the amplitude over time. The oscillation starts at the zero line. A positive amplitude follows. Then the oscillation changes to a negative amplitude. Here it crosses the zero line. The zero crossings define the phase. The frequency of the oscillation is calculated from the distance between the zero crossings. The oscilloscope shows the time course of the oscillation. For a better understanding and calculation of oscillations, the time axis is normalised, the angular frequency is introduced. In this way, a reference oscillation is defined whose zero crossings form the reference point. The change in the distance between the zero crossings is described by an angle and shown in the phase frequency response. The reference oscillation with the phase angle 0 is decisive for the representation. In the case of electrical oscillations, it is a very low frequency and thus well defined. Sound waves cannot be measured directly like electrical oscillations. Since a delay occurs due to the distance from the loudspeaker to the microphone, the zero vibration is no longer precisely defined. Also, this cannot be generated by the loudspeaker. For the measurement of the acoustic phase frequency response, however, a zero phase must exist. In almost all measuring systems, the zero phase should be found by measuring the impulse response. Why this does not work is very complicated to describe. With the ATB measuring programme the zero phase is found by very complex mathematical calculations and the correct phase curve is measured. The ATB Audio Analyzer programme has a very accurate distance measurement that shows the measurement of the correct phase frequency response. Phase is used in the description of sinusoidal processes such as mechanical oscillations, alternating current, radio waves and sound waves.

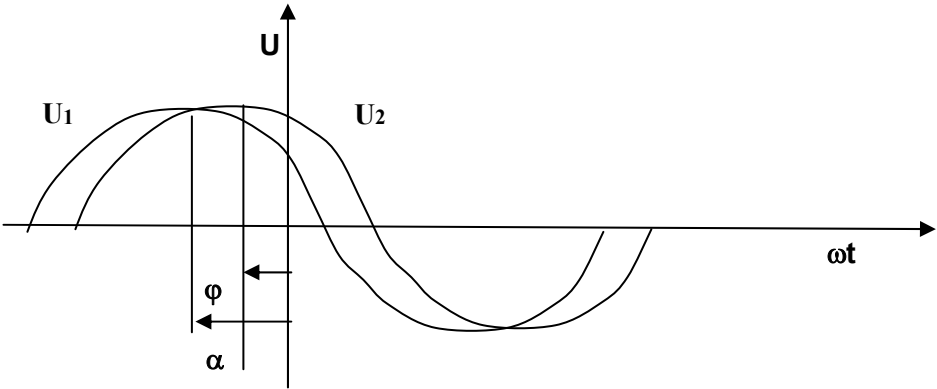


$$U(t) = U_s \cos(\omega t + \alpha)$$

**t** Zeit, **U(t)** Augenblickswert der Spannung, **U<sub>s</sub>** Scheitelwert (max. Amplitude),  
**f** Frequenz, **T = 1/f** Periodendauer,  $\omega = 2\pi f = 2\pi/T$  Kreisfrequenz,  
**α** Nullphasenwinkel

Kirchner elektronik

The phase angle already appears in the basic equation. There it is arbitrarily set by a reference point, the time 0. In the case of two or more oscillations, which are present e.g. in acoustic signals, the phase angle is important for the description of the measurement.

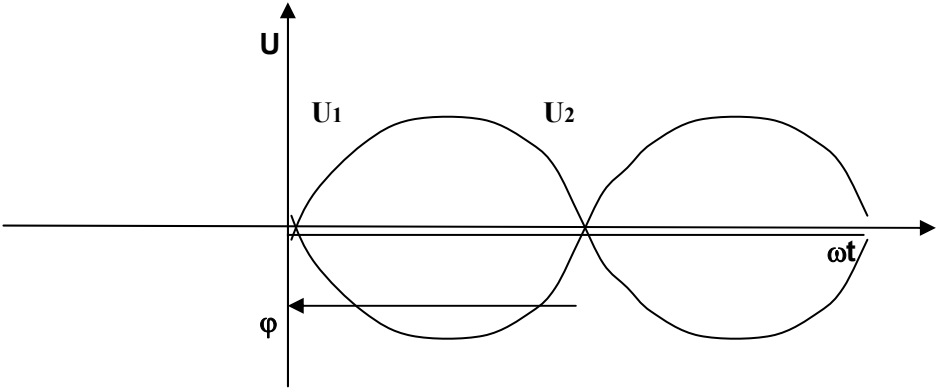


$$U(t) = U_{s1} \cos(\omega t + \alpha) + U_{s2} \cos(\omega t + \alpha + \varphi)$$

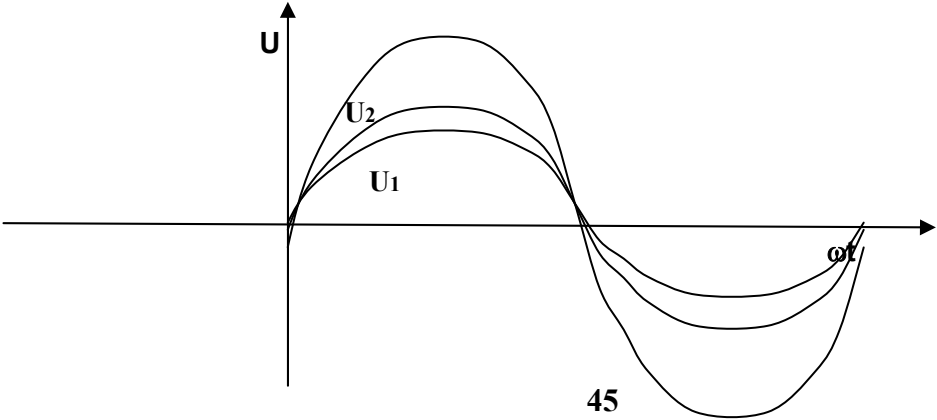
The angle  $\varphi$  determines how the vibrations are superimposed.

Examples of the effect of the angle  $\varphi$  on the vibration:

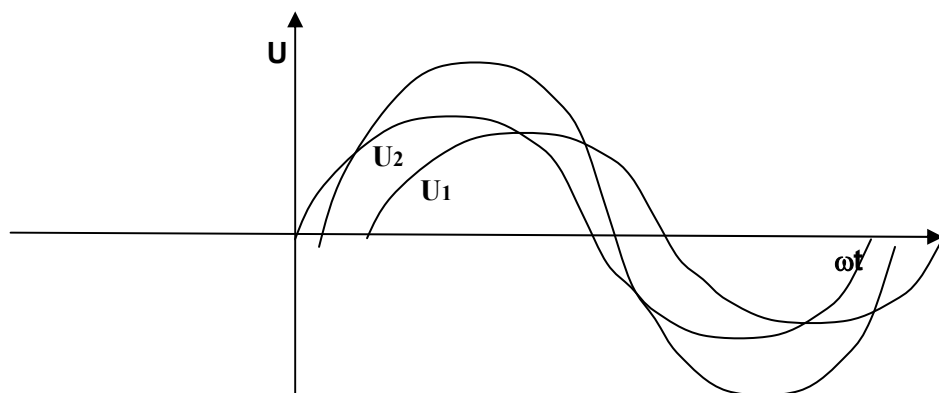
$\varphi = 180^\circ \Rightarrow$  Auslöschung



$\varphi = 0^\circ, 360^\circ \Rightarrow$  maximum amplitude



$\phi = 90^\circ, 270^\circ \Rightarrow$  partial reinforcement, or also as partial extinction

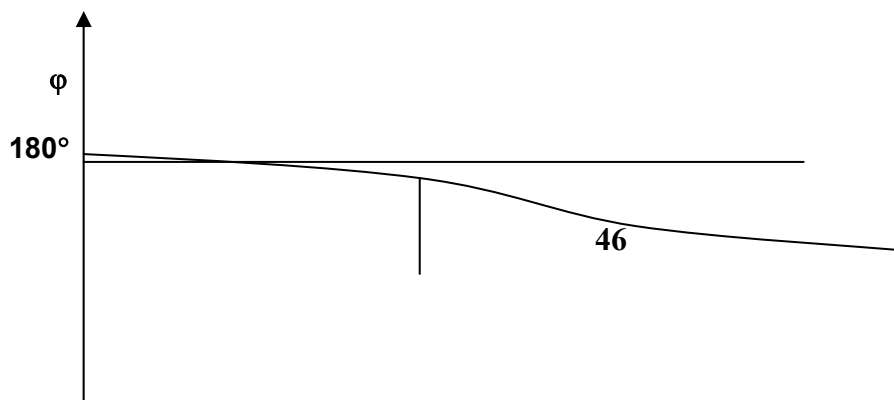


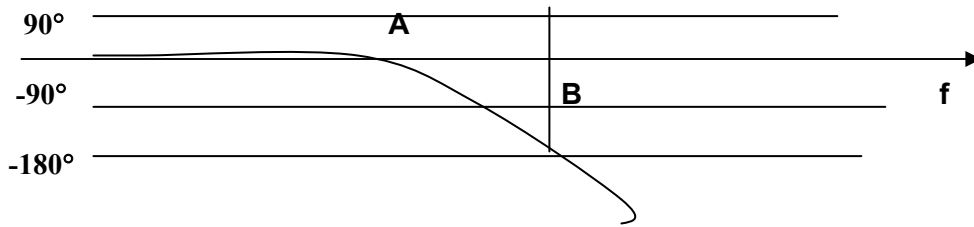
## 6.2 THE PHASE AT THE LOUDSPEAKER

The phase represents the temporal allocation of vibrations over the frequency response. The phase curve shows whether the loudspeaker can reproduce an instrument correctly. An instrument produces the fundamental and a series of harmonics. The phase shows whether the fundamental is reproduced at the same time as the harmonics. If the phase rises in the diagram, the overtones are produced before the fundamental. If the phase drops, the overtones are reproduced too late. Phase jumps that completely confuse the assignment of fundamental and overtones produce a new, artificial sound.

The basics of physics apply to a loudspeaker. A correct description of the radiated sound pressure includes the amplitude and the phase. The usual theory that the phase can be seen in the frequency response is wrong. This is only the case with simple electrical circuits. In a loudspeaker, the very complex transfer function, which also contains propagation times, prevents phase detection from the amplitude frequency response. A loudspeaker with an absolutely smooth frequency response can have extreme, and therefore audible, phase jumps. A common practice for detecting the phase relationship in a loudspeaker is as follows. In order to detect the phase relationship from the frequency response between two individual loudspeakers, at the transition e.g. from the midrange to the tweeter, the crossover is constructed in such a way that a maximum cancellation occurs between the two loudspeakers. If after polarity reversal of one of the two speakers the frequency response is balanced, the phase relationship is also correct. In this case, however, the phases are usually 180, 360 or 540 apart and the transient response is poor.

Outside the crossover frequency, the method is unsuccessful. This is shown in the following example.





The picture shows the phase behaviour of low-pass and high-pass filters

A = phase of 180 determined according to the method described above.

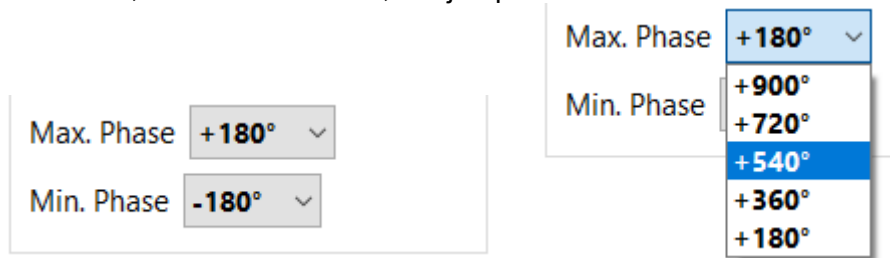
B = phase angle of 270. At this angle, the sound components of the midrange and tweeter partially cancel each other out. Reversing the polarity of the speakers shows the same frequency response, so that the error in the crossover design cannot be detected in the usual way. Since at a phase angle of 90, 270 the individual loudspeakers are too loud, an annoying sound is produced. In this case the usual frequency response measurement is meaningless.

Numerous studies show that a balanced phase frequency response is absolutely necessary for natural sound reproduction.

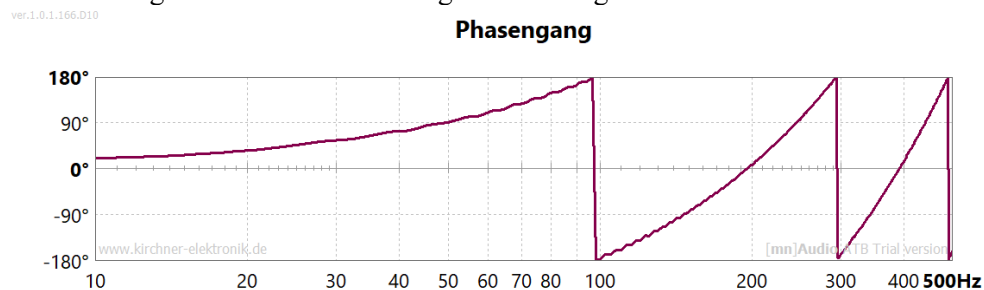
### 6.3 PHASE DIAGRAM

The phase can be displayed in wrapped or unwrapped form.

In the wrapped representation, the phase is displayed in the range of  $+180^\circ$  and  $-180^\circ$ . Here the curve often has jumps of  $360^\circ$ . These jumps confuse many users because they have to imagine that the curve continues outside the diagram. That is why there is also the unwrapped representation. With this representation, the limits of the diagram can be set to values greater than  $+180^\circ$ ,  $-180^\circ$ . In this case, the jumps in the curve are avoided.



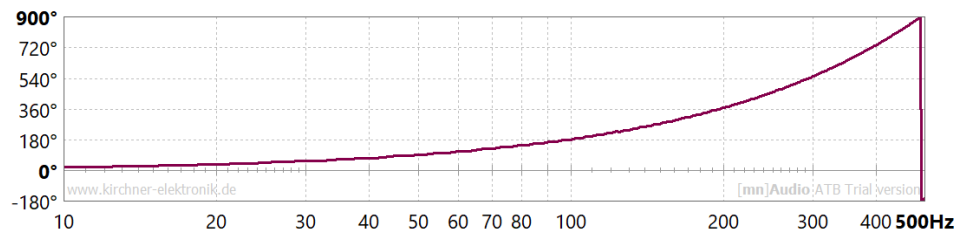
These settings are used to set the range for the diagram in the measurement menu under Display.



Wrapped

Kirchner elektronik

### Phasengang



### Unwrapped

The unwrapped representation leads many designers to misunderstand the phase of the loudspeaker. The developers measure a straight slanted line from  $900^\circ$  to  $-900^\circ$  and are convinced that the phase is very balanced. However, this representation gives no indication of correct reproduction. Optimal reproduction exists with a straight phase curve.

This representation does not show the constant group delay. In phase measurement, the constant group delay is a straight line.

## 6.3 ELEKTRISCHE PHASENMESSUNG

The electrical phase measurement is done with the magnitude measurement.

Attention: The phase measurement is started with the time calibration in the distance meter.



The phase measurement requires the time calibration. This measures the time behaviour of the computer and sound card. The operating system creates a delay between the start of the generator and the conversion of the input signal. The time correlation measures the delay and compensates for it in the following measurements. With the DSP, the output voltage can also be measured during time correlation. This means that the latency has no influence on the phase.

Electrical phase measurement is used to measure the phase of hi-fi or studio equipment.

The measurement is particularly interesting for passive and digital DSP crossovers. With the DSP crossovers, the delay is measured by the DSP with the distance measurement and used in the measurement.


The input of the devices is connected to OUT and the output of the devices to the test adapter or the MAG input.



## 6.4 ACOUSTIC PHASE MEASUREMENT

The acoustic phase measurement is carried out with the SPL measurement.

Attention: The phase measurement is started with the distance measurement.

**DISTANCE METER**

Measure

<input checked="" type="checkbox"/> <b>Time calibration</b>		<input checked="" type="checkbox"/> <b>Distance</b>	
Input	<b>Right</b> ▾	Input	<b>Left</b> ▾
Output	<b>&lt;All&gt;</b> ▾	Output	<b>&lt;All&gt;</b> ▾
Result	<b>19,609</b> ms	Distance	<b>110</b> mm
		Delay	<b>0,320</b> ms

The distance measurement measures the distance from the acoustic centre of the loudspeaker to the microphone to the nearest mm.

The amplifier for the loudspeakers is connected to OUT. The input signal comes from the microphone connected to MIC.

Acoustic phase measurement from a loudspeaker can only be done in quiet rooms. It is not as insensitive to interference voltages as the frequency response measurement. Strong reflections in the measuring room also falsify the result. In small rooms, the distance should not be > 0.5m.

## 6.5 IMPEDANCE PHASE MEASUREMENT

The impedance phase measurement is carried out with the impedance measurement.

Attention: The phase measurement is started with the Time Calibration measurement in the Distance Meter.

**DISTANCE METER**

**Time calibration**

Input	<b>Right</b> ▾
Output	<b>&lt;All&gt;</b> ▾
Result	<b>19,609</b> ms

Time Calibration is used to test the time behaviour of the computer.

With impedance phase measurement, the phase of loudspeaker impedance, for example, is measured. This measurement is necessary for the interference-free operation of the loudspeaker. Large phase angles show a capacitive or inductive behaviour of the loudspeaker impedance. The result is an overload of the amplifier. The amplifier can also become unstable and generate oscillations.

The impedance measurement is carried out with the test adapter. The loudspeaker is connected to IMP.

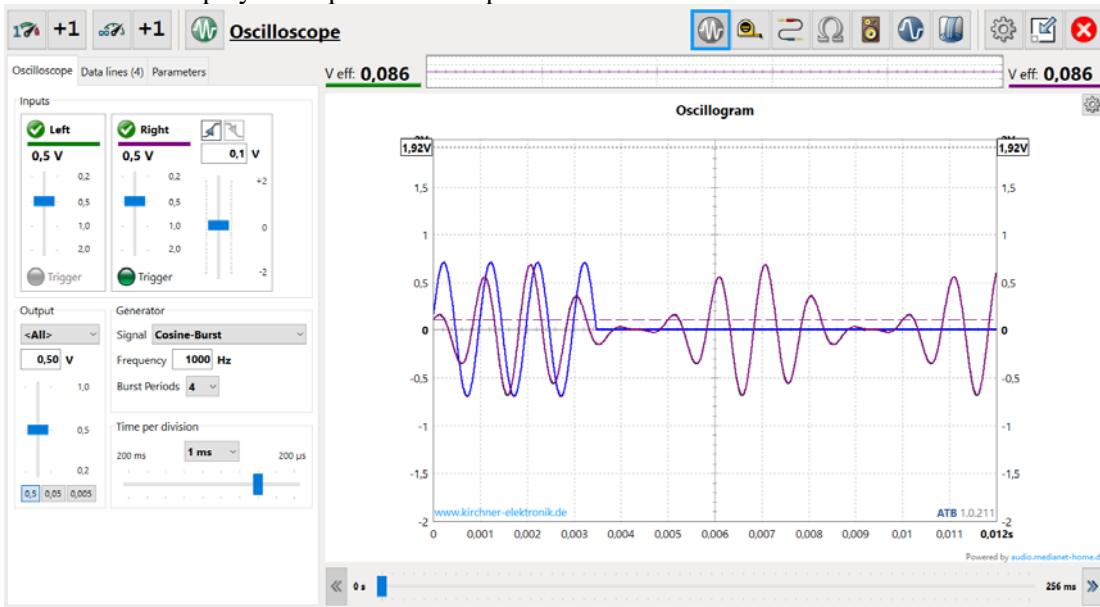
**Kirchner elektronik**

## 7. OSCILLOSCOPE



This button is used to call up the oscilloscope measurement.

It is a 2-channel memory oscilloscope with generator. Calibration makes it a real measuring instrument with accurate display of amplitudes and quartz time.



### 7.1 GENERATOR

The oscilloscope has a generator for measuring signals. During the measurement, the generator and transducer for the signal to be measured are started in a time-assigned manner. After the measurement, the generator is stopped. The following signals can be selected for the generator:

In the generator menu, the signal form and the frequency for the signal are selected. In the output menu, the output voltage and the channel are set.

Kirchner elektronik

## 7.2 VOLTMETER

The continuous measurement shows the effective value in volts of the signal.

V<sub>eff</sub> **0,997**

Due to the calibration, the accuracy corresponds to a high-quality level meter.

## 7.3 MESSUNGEN

The oscilloscope has a single measurement function in addition to the familiar measurement process, in which the input signals are continuously shown after the start of the measurement.

### Current measurement

The measurement corresponds to the familiar hardware memory oscilloscope.



The measurement is started with the button at with the measurement according to the hardware oscilloscope. The previous measurements are deleted.



The button stops the measurement. After the stop, the last measurement is shown.



The button starts the measurement while continuing to show the previous measurement. This way the measurements can be compared.

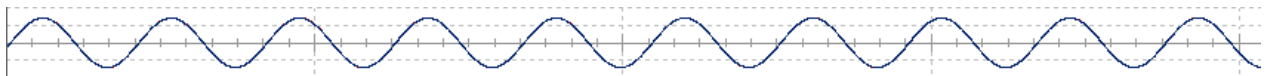


The button stops the measurement. After stopping, the measurement is shown according to the storage oscilloscope together with the previous measurements.

The measurements shown are listed under the data line map and can be edited. The number of curves is only limited by the PC memory. From 20 curves, the display becomes confusing and the measurements take longer.

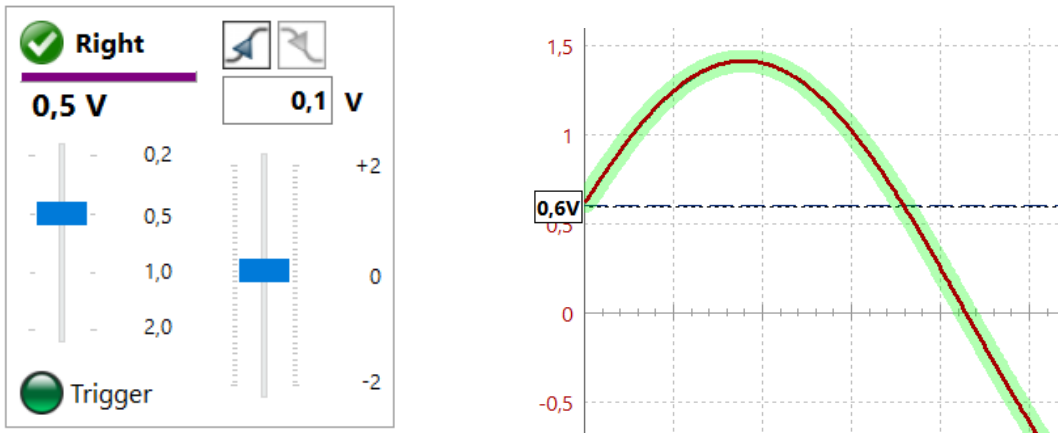
### Signal control

Above the diagram, the entire signal is shown in an oscillogram. If by a delay longer than the time selected in the diagram, the signal can be seen here.



## Trigger

Like the hardware oscilloscope, the measuring programme also has a trigger. The trigger function is needed to obtain a stationary image during continuous measurement.



The trigger is activated in an input selected for the measurement. In the trigger, the trigger threshold is determined with the slider or with the input field above the slider. In the diagram, the trigger threshold is shown by a dashed line. The diagram opposite shows the measured sine curve. The display starts at the trigger threshold.



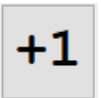
The buttons can be used to select the edge on which the trigger point is to be located. A distinction is made between positive and negative edges. Here, triggering is done on the positive edge.

## Single measurement

The single measurement is very necessary for the representation of temporal assignments of signals. This measurement can only be carried out by hardware devices with great effort. During the measurement, the generator and the transducer for the signal to be measured are started synchronised in time. The time allocation of the start of the generator and the start of the input converter depends on the operating system and the USB sound cards. Therefore, the programme has the Time Calibration function. The function measures the delay between the start of the generator and the start of the input transducer. The delay is compensated during the measurement. This makes a very accurate distance measurement possible.



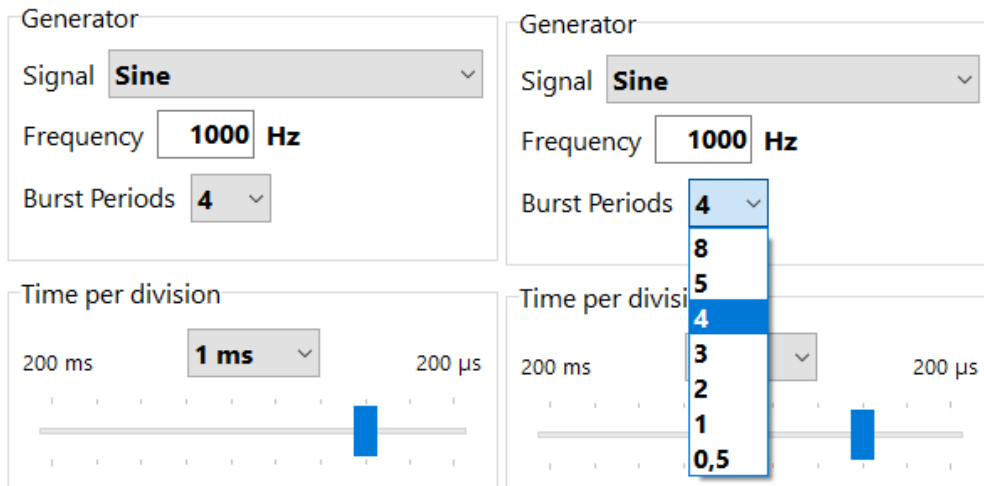
The button starts the individual measurement as a new measurement. The previous curves are deleted. The measurement stops automatically after 240ms at a sample rate of 48 kHz.



This way the measurements can be compared. The measurement is stopped automatically.

In single measurement, burst measurements can be taken with the generator.

**Kirchner elektronik**



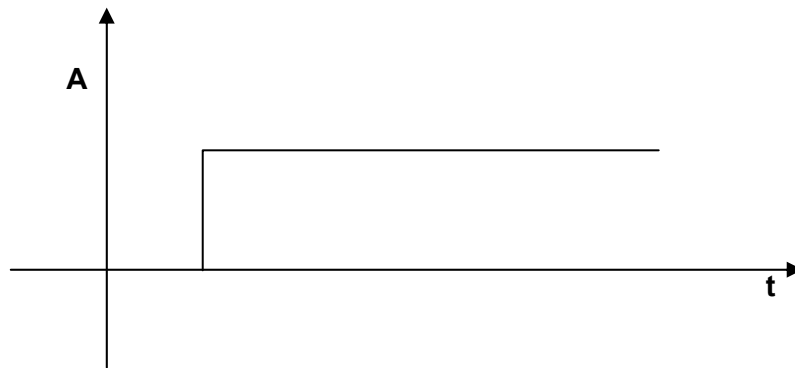
The setting of the burst length is very important. Especially the 0.5 period is important for the step response and dynamic measurement.

## 7.4 STEP RESPONSE

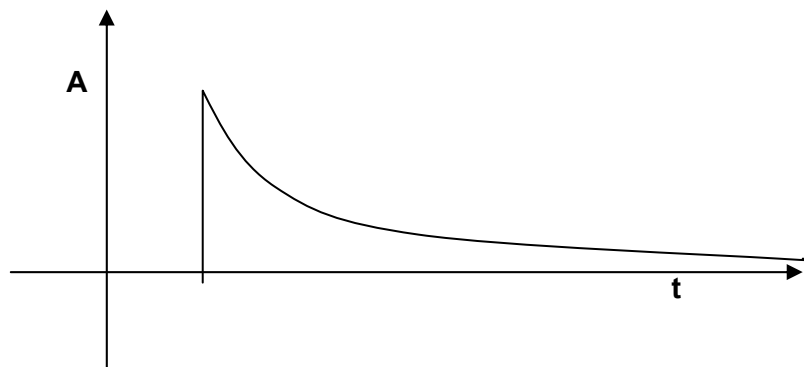
The step response shows the amplitude and phase simultaneously. This contains all the important information about the properties of a transmission line.

Step response image of a linear transmission line

Step: image of the step response



Step response of the loudspeaker



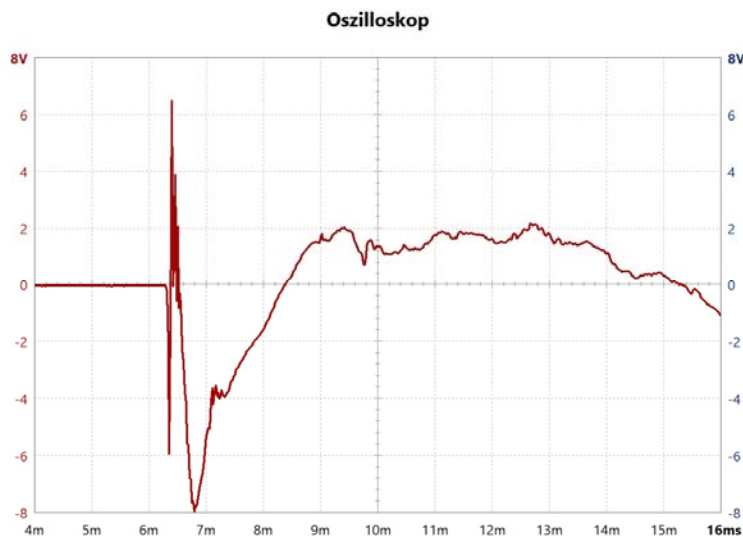
The signal rises steeply and falls according to the e-function. The drop is caused by the differentiating function of the air.

For the measurement, the square wave signal is set to 10Hz for the generator.

The picture shows an ideal loudspeaker. The steep rise of the step response shows a high upper cut-off frequency. The drop corresponding to the e-function shows a linear frequency response. The lower cut-off frequency can be seen from the steepness of the drop. The decisive factor in the measurement, however, is the statement about the phase behaviour. Since the step response only shows rise and fall, all individual speakers are on the acoustic plane and have the same polarity. Also, the phase of the loudspeaker is linear. Common loudspeakers show several peaks and valleys depending on the number of individual drivers.

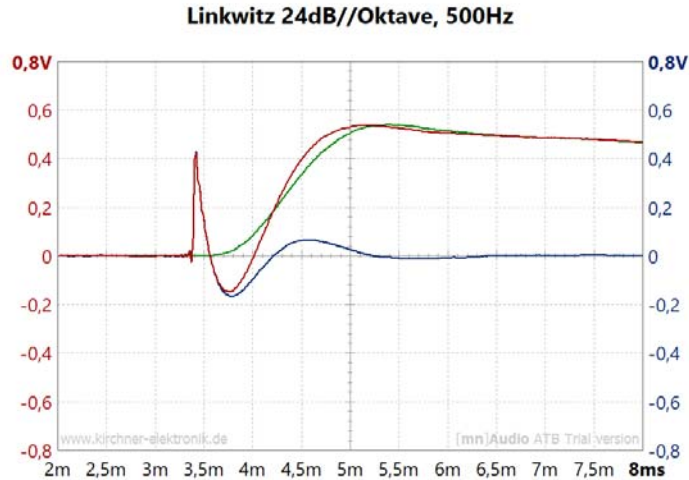
### Step response measurement

The single measurement is used. For the generator, the square wave with 20Hz and the period length 0.5 are selected.



The picture shows the step measurement of a loudspeaker. It shows the sound pressure over time when excited with the square wave signal. In this loudspeaker, the negative peak at the beginning shows the tweeter. The following positive peak is the tweeter resonating. This is followed by the negative peak of the mid-bass driver. This resonates in the positive range. The picture shows that the leading tweeter is well matched to the midrange driver.

Step response of a DSP Linkwitz crossover, 24dB/octave, crossover frequency 500Hz,  
The low pass signal and the high pass signal are added to the sum signal by an analogue adder.



The measurement shows how the signal of the low-pass and high-pass add up to the step response. Green = low pass, blue = high pass, red = sum. The signals add up over a wide range.

The blue curve for the high pass also shows the strong resonance of a Linkwitz filter with 24dB/octave.

## 7.5 DYNAMIC MEASUREMENT

The Dynamic Measurement was developed by Michael Weidlich and Leo Kirchner. It is a measurement that shows the temporal course of a signal, an oscillogram. The oscillograms are measured for different frequencies and shown in a 3D diagram. The special thing about the measurement is that a sine with a period length of 0.5 is used as the measurement signal. It is only a positive pulse. The impulse excites a transmission path without creating a steady state. Hence Dynamic Measurement. The 3D spectrum shows a step response in which the step over the frequency range is displayed. The representation is mathematically correct. Because amplitude, phase and transient response are displayed at the same time, the 3D display can only be understood by experts. Therefore, no further research was done on the measurement method.

Nevertheless, the measuring method is extremely important for loudspeaker development. The measurement signal, the half sine wave, corresponds very well to an impulse in music. With the measurement, it can be determined very quickly whether the music reproduction of a loudspeaker is correct.

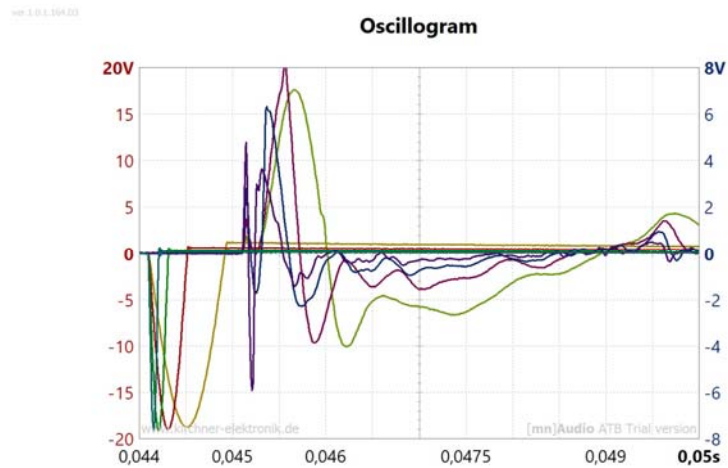
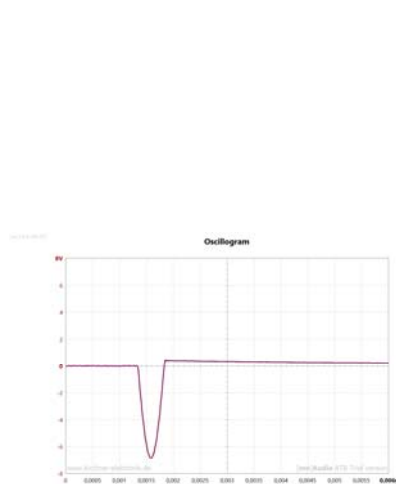
Most amplifiers cannot transmit the impulse in the low frequency range. With the help of the measurement it can be determined exactly whether the amplifier has a dry or a voluminous bass.

It is also very interesting to see what a filter circuit does with the impulse. A DSP with a programmed filter circuit does not allow the impulse to be recognised.

Also sound cards cannot reproduce the impulse path of their high pass function originally. By comparing the signal at the output of the sound card with the signal at the output of the unit under test, a measurement result is obtained.

**Kirchner elektronik**

## Dynamic Measurement of 2-way loudspeakers



Sinus 0,5 Period Bust

2-way loudspeaker

During the measurement, the measurement signal is shown from 0s. The frequencies are 600Hz, 1200Hz, 2400Hz, and 4800Hz. The sound pressure of the loudspeaker is inverted. At the beginning the signal of the tweeter is shown. It is very small for low frequencies. The tweeter resonates far into the negative range. It is not polarised with the mid-woofer. After the tweeter's swing-through comes the midrange signal. It has the highest amplitude and the strongest swing-through at 600Hz. With the usual construction of loudspeakers without time equalisation between the loudspeakers by matching the acoustic levels, both loudspeakers are to be seen as single impulses. In the transition area from the low-midrange to the tweeter one impulse becomes two with the same amplitude. This is not visible in the frequency response measurement. The frequency response is very balanced. The speaker sounds quite good with poor spatial reproduction. Decisive for the quite good sound is that the signals of the tweeter and the low-midrange are cleanly separated. The crossover is designed in such a way that the signals from the two speakers do not cancel each other out for any frequency. The dynamic measurement is an important aid in loudspeaker development.

Kirchner elektronik



## 8. DISTANCE METER

### 8.1 OPENING THE MEASUREMENT



The button calls up the distance meter

The rangefinder consists of two measurements. These can be started individually and together. The first measurement is the time calibration. This newly developed function is the basis for all time-dependent measurements such as oscilloscope, phase, distance and waterfall. The measurement determines the time that the PC and the sound card need to manage. After the start of the output of the measurement signal, a sometimes long time, delay, passes until the start of the conversion of the input signal. However, since both functions must be started at the same time for an accurate measurement, the time of the delay is taken into account in the measurement.

Result

2,396 ms

Result of time calibration, is automatically taken into account.

The second measurement is the distance measurement. It measures delays, Delay, of electrical equipment and the distance, Distance, of the microphone from the speaker. This measurement is needed for accurate phase measurement.

The frequency response measurement with the ATB or sine sweep signal does not require the setting of delays or distances because of the correlation function of the programme.

Distance

0 mm

Delay

0,000 ms

Result of the distance measurement

The distance meter can also be called up from the SPL and waterfall measurement via the measure buttons.



The return is made by this button

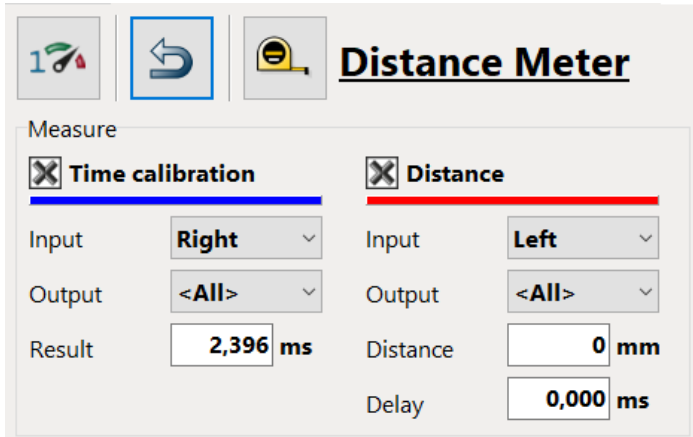
The distance meter is the crucial measurement for modern sound reinforcement and loudspeaker technology with DSP. With the measurement, the delay is set exactly.

With the known PC measuring systems, the distance measurement is only possible with the 2-channel measurement. The measurement function is the impulse. However, this does not show any usable result in the acoustic loudspeaker measurement. With the ATB Audio Analyzer, the distance is measured with a signal whose frequency lies within the transmission range of the loudspeaker. With the impulse measurement, the beginning of the impulse is shown for the highest frequencies. However, these are offset in time from the frequency range used. Another new feature of the ATB Audio Analyzer is that the distance can be measured accurately with a simple sound card without two microphone inputs. The measuring programme offers two methods for distance measurement, the one channel and the two channel,

2-channel, measurement.

Kirchner elektronik

## 2-channel, measurement



The distance measurement measures the distance for the SPL and waterfall measurement and the delay for the magnitude measurement. Both values are measured independently according to the setting. If the distance measurement is called up from a measurement, the values are taken over into the measurement and the corresponding measurement is called up with the Return button.

With "Do not apply" the temporal behaviour of the computer is measured for the phase in the impedance measurement and used for the display of the phase. In this case, values for SPL, waterfall and magnitude measurement are not changed.

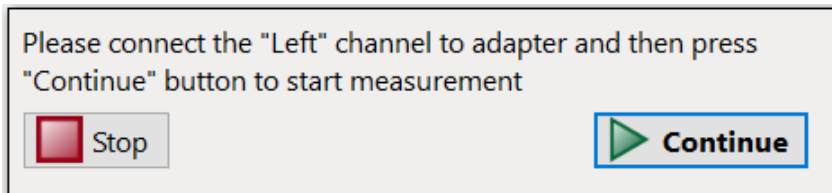
The measurement of time calibration and distance can be measured individually or automatically one after the other. This is determined by ticking.

The measurement of time calibration should be done after each restart of the programme. During measurement, it is necessary when new programmes are called up. This change the time for the administration of the sound card. The measurement requires the test adapter. The sound card output and input can be determined in the programme.

1. If the test adapter is designed for one channel, the input used for calibration is set. The output is set to all. During the measurement, the microphone and amplifier are exchanged for the adapter
2. If the adapter is designed for two channels with the switch position 2-CH, the setting is set to the opposite input, usually right, during calibration. The output is set to the same channel as the input.



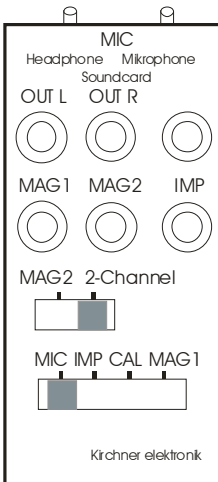
The button starts the measurement.



This message follows.

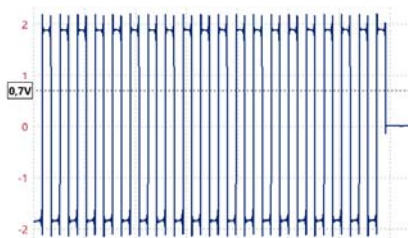
If the right channel is selected, it is also used.

**Kirchner elektronik**



The ATB Audio Analyzer test adapter supports 2-channel measurement.

When measuring the distance loudspeaker-microphone, the input of the power amplifier is connected to OUT L. The microphone is connected to the MIC input. The switch for the left channel is set to 2-channel. Here, the sound card output for the left channel is connected to the left input of the sound card via a voltage divider.

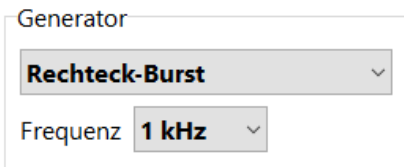


The result of the time calibration

For the first distance measurement, the time calibration is carried out together with the distance measurement. Time calibration is not necessary for further measurements.

The input channel used during calibration is set for the input. The output channel is set to all.

The one-channel distance measurement is used for the sound cards with a microphone input. The measurement frequency is selected for the measurement.



In the generator menu, the frequency for the loudspeaker measurement is selected.

Measurement:

3kHz for the tweeter, 300 Hz for the midrange, 60Hz for the bass and 1kHz for the whole speaker.

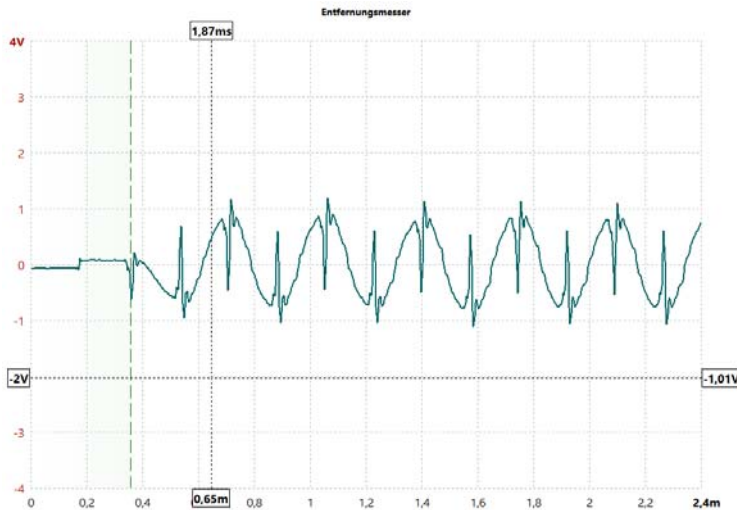
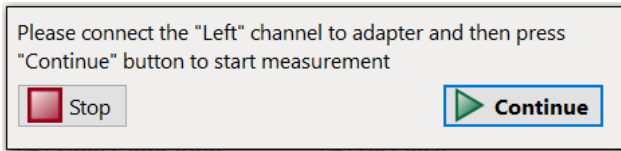
The volume is set with the output voltage control.



The button starts the measurement.

**Kirchner elektronik**

The menu indicates that the adapter connects the headphone output to the microphone input.



The diagram shows the loudspeaker measurement. The distance is shown from 0 to the dashed green line. By touching or clicking on the line, the distance is transferred to the programme.

With this measurement it is possible to determine the acoustic centre of a loudspeaker to the mm. This is not possible, for example, with the impulse measurement of most loudspeakers.

For the acoustic phase measurement it is sometimes necessary to change the position of the phase curve. For this purpose, there is the possibility to determine the distance in the measurement curve with the cursor. Since the loudspeakers almost always do not have the same acoustic centre, a correction of the automatically determined distance is necessary. This correction does not change the measured values. Only the slope of the curve is changed in the display.

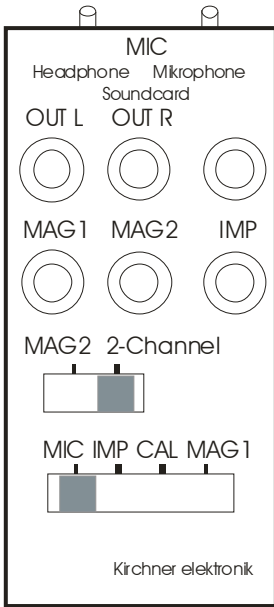
When measuring the distance loudspeaker-microphone, the power amplifier is connected to OUT L and the microphone to the MIC input. The switch for the left channel is set to 2-channel. Here, the sound card output for the left channel is connected to the left input of the sound card via a voltage divider.

## 8.2 LATENCY

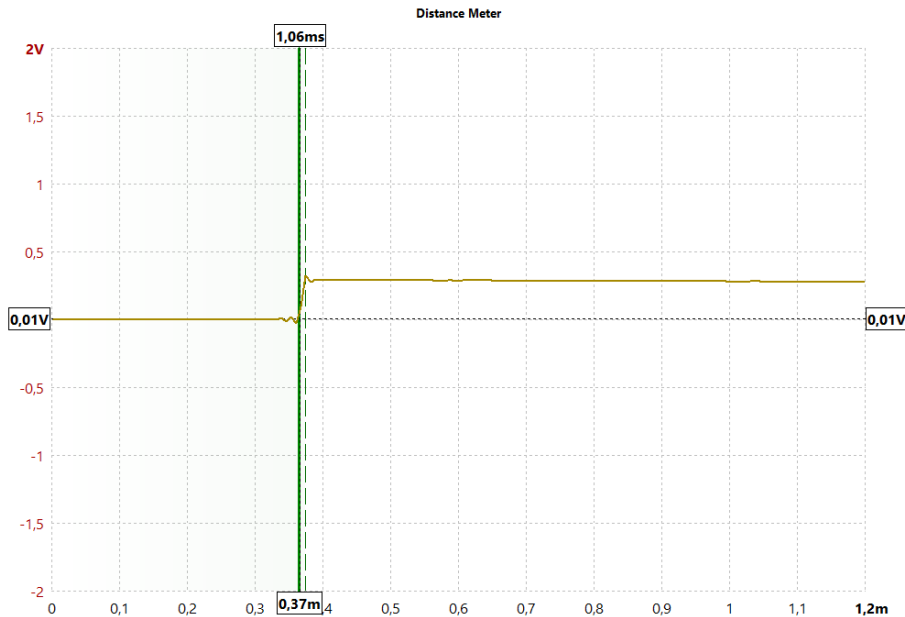
Latency is an important factor in DSP. Wherever speakers or musicians are amplified, this time must not be too long. From 3ms latency on, the speaker and the system are heard separately, which severely impairs speech intelligibility or music reproduction. This is also unpleasant for the listener, especially with music. The latency can be determined exactly with the distance measurement. Here, the 1-channel or 2-channel method works.

For the 2-channel method, the 2-channel adapter is used.

**Kirchner elektronik**



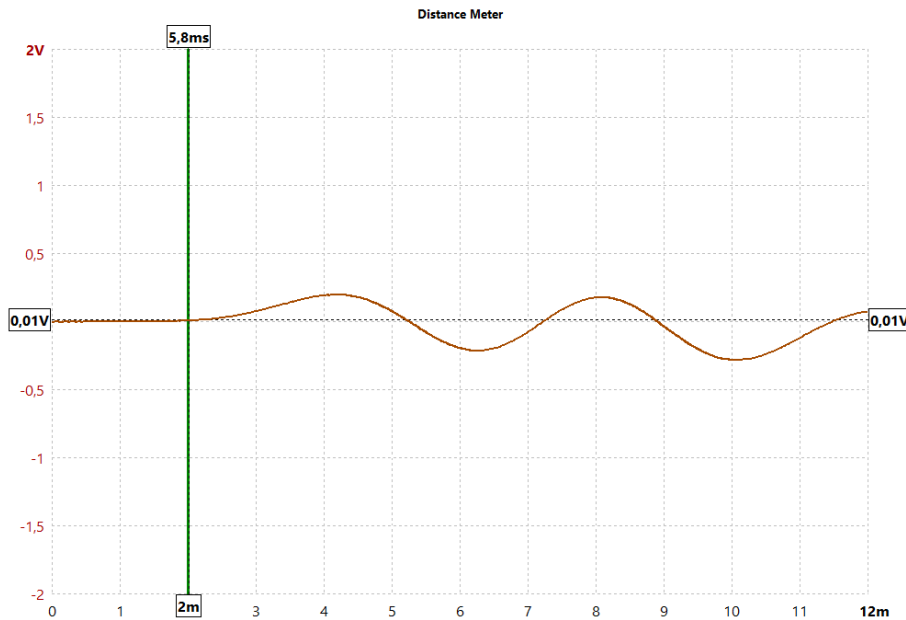
The DSP input is connected to OUT 1 and the output to MAG1. The 2-channel switch to 2-Channel and the measurement switch to MAG1.



With the Mini DSP, the latency is 1.1ms. In this time the sound travels 0.37m

With the distance measurement, the delay caused by a filter function in the DSP can also be measured. A low-pass filter with 48db/octave at 100Hz is set in the DSP. To be able to measure the transmission, 100Hz is selected as the measuring frequency. The latency time is also taken into account by measuring the DSP output signal from a channel switched to linear during calibration, the first measurement. The latency time can also be measured with the output signal of the sound card. Then the previously measured time is subtracted from the measurement result.

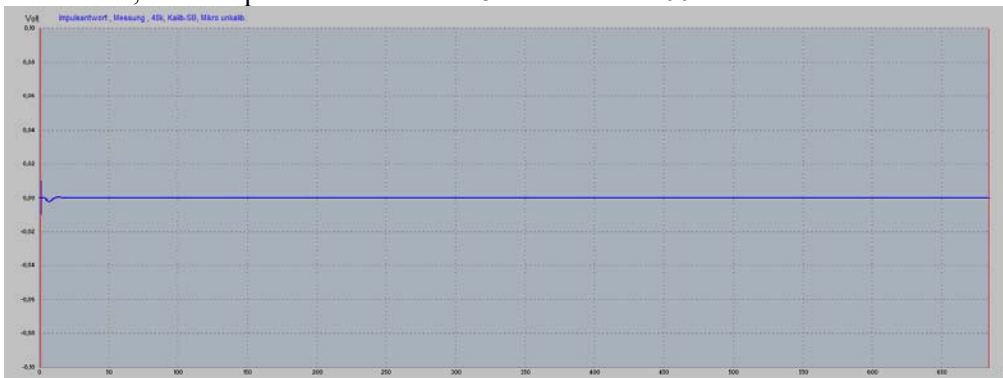
**Kirchner elektronik**



The delay is 5.8ms. This value must be taken into account when setting the delay.

The advantages of the distance meter with DSP measurement are shown in the comparison with the LMS impulse response.

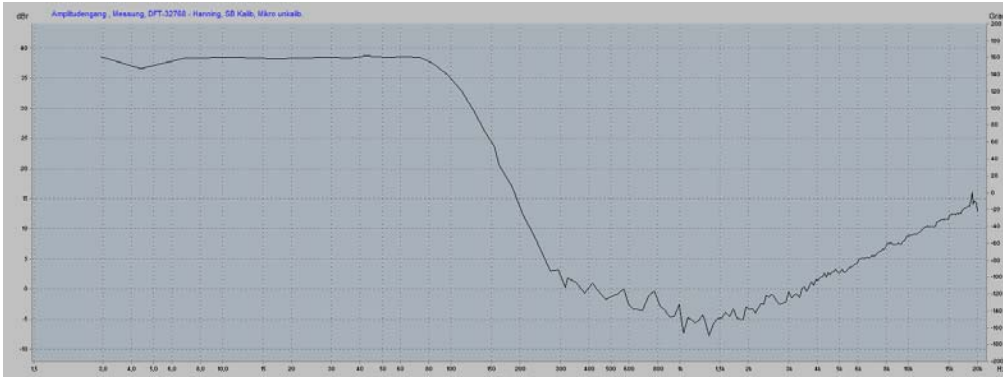
In the DSP, the low-pass filter is set to 48dB/octave at 100Hz.



In the impulse response, there is not a faint trace of the measured signal. The impulse response only shows the amplitudes for frequencies in the high range. The amplitudes for the low frequencies, whose time delay is to be measured, can no longer be recognised due to the distribution over the time range. No time measurement is possible.

This is also the problem with the phase measurement of all measuring programmes that measure with the impulse response. With some, the impulse response is not shown, but the problem remains. These programmes can measure the electrical phase but not the acoustic phase with a running time.

The ATB PC Pro determines the distance with a very complex calculation. It is the only programme that measures the acoustic phase correctly without any settings by the user.



### Frequency response from the impulse response

The example shows that with the impulse response the temporal behaviour of subwoofer and mid-high speakers cannot be adjusted. This is possible with the distance measurement.

With the 1-channel or 2-channel measurement, the crossover frequency of the subwoofer and mid-high loudspeaker is selected as the measurement signal. Please note that the polarity of the subwoofer and mid-high speakers is reversed. The distance is measured for both speakers and the difference is set in the delay of the digital crossover.

The result is then checked with the frequency response and phase measurement. The step response with the oscilloscope single measurement also shows whether the delay is set correctly.

This is very important for sound reinforcement systems or for the sound system in a car.

## 9. MAGNITUDE



The button calls up the magnitude measurement.

The magnitude measurement is an electrical measurement.

According to the setting, three different measurements can be performed:

Frequency response measurement

Phase measurement

With the 2-channel adapter, the device to be measured is connected to OUT L, OUT R and MAG1, MAG2 and the switches to MEAG2 and MAG1.

### 9.1 FREQUENCY RESPONDS

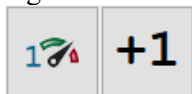
Because of the correlation function, the delay of a DSP does not need to be set for frequency response measurement.

For the phase measurement, the time behaviour of the computer and the connected device is decisive. Therefore, the time calibration measurement is carried out before the phase measurement. If a DSP is in the playback section, the input signal for the time calibration is taken from behind the DSP.

In the Generator menu, the ATB or sine sweep signal is selected. The two signals have identical measurement accuracy.

In contrast to the sine sweep measurement, the ATB measurement signal can also be played back from a CD or DVD player or as .wav from a USB stick. This is very convenient when calibrating the car sound system, as connecting the PC sound card to the car sound system can be very complicated.

The Surround Test DVD can also be used to precisely adjust the system in the home cinema. Since the user can control the process, in contrast to the automatic calibration systems, a clear advantage can be achieved in the reproduction. This is not due to the inaccuracy of the automatic measurements but to the algorithms for the correction reproduction. These do not correspond to the listening experience.

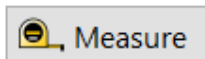


The measurement is started with the single measurement buttons.

The measurement is used to measure the frequency and phase responses of the amplifier, mixer or DSP.

Through the time calibration function, the frequency and phase responses from the DSP can also be measured with latency.

As an example, the Mini DSP is measured with the filter settings Butterworth 6dB, 12dB, 18dB/octave at 100Hz.



The measurement is used to measure the frequency and phase responses of the amplifier, mixer or DSP.

With the Time Calibration function, the phase response of the DSP can also be measured with latency.

As an example, the Mini DSP is measured with the filter settings Butterworth 6dB, 12dB, 18dB/octave at 100Hz.

**Kirchner elektronik**

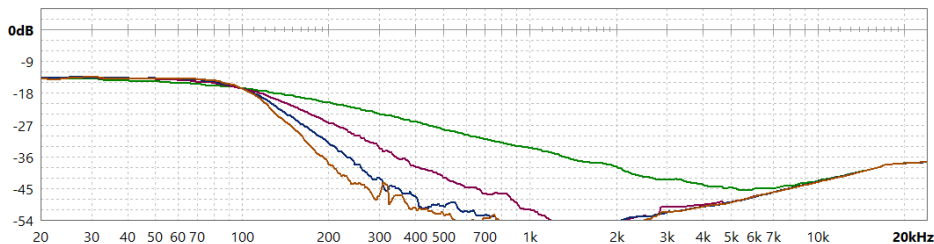


Result

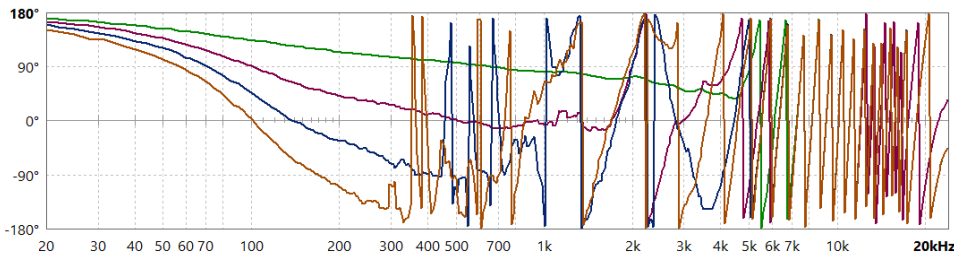
19,609 ms

The delay is transferred to the magnitude measurement. This enables the correct phase measurement with the DSP. The increase for high frequencies is a crosstalk of the measuring arrangement. The fluctuations for high frequencies show that at low levels the phase evaluation of the FFT no longer works. However, these low levels have negligible significance for the transmission behaviour.

DSP Messung, Butterworth 6dB, 12dB, 18dB/octave 100Hz



DSP Messung, Butterworth 6dB, 12dB, 18dB/octave 100Hz



## 9.2 PHASE

The phase measurement shows the temporal allocation of the individual frequencies. This is determined by all the circuits that determine the frequency response. This includes the filter and equaliser functions. The FIR filters eliminate the influence of the filters on the phase. However, the linear phase is bought with an influence on the temporal behaviour of oscillation in and out. This destroys the usual behaviour of transmission lines and results in an artificial, unnatural sound. The FIR filters destroy the usual temporal behaviour of impulse reproduction.

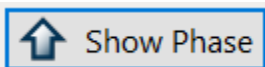
The measurement of the phase requires the adjustment of the distance. See example in frequency response measurement.

When measuring with a signal from the CD / DVD player, phase measurement is not possible.

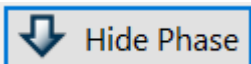
The reason for this is that the distance cannot be determined.

The phase measurement with CD / DVD player is only possible with the ATB PC Pro through a very

complex calculation.



The button opens the diagram for the phase.



The button closes the diagram.

## 10. IMPEDANCE METER



The button opens the impedance meter.

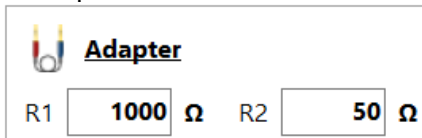
Before the phase impedance measurement, the time calibration is performed to test the temporal behaviour of the computer. The frequency response measurement of the impedance does not require time calibration. ATB or sine sweep can be used as the measurement signal. Due to the different time behaviour of the two signals, there may be deviations in the low frequency range of loudspeakers. The ATB signal shows the same measurement as the measurement with discrete sine signals. These are the basis for the impedance measurement.

The impedance is the frequency-dependent resistance for alternating current. It consists of the magnitude  $Z$  in and the phase in. The measurement shows the two values over the frequency range. The phase shows that of the reactance and active resistance, which together form the magnitude  $Z$ . At  $= 0$  only the active resistance exists and at  $= 90$  only the reactive resistance.

The impedance measurement is needed in the development and testing of loudspeakers. It is a measure of the load on the power amplifier by the loudspeaker. Small values of  $Z$  require powerful amplifiers. The phase shows whether the amplifier is becoming unstable. It generates its own oscillations that destroy the loudspeakers. The phase angle should not be  $> + 60$ .

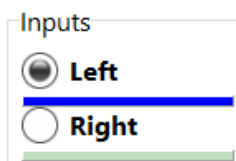
Impedance measurement can also be used to test electrical components such as resistors, capacitors and coils.

The impedance measurement is carried out in the ATB programme via a measuring resistor. The voltage at the impedance to be measured is measured and converted into the  $\Omega$  value.



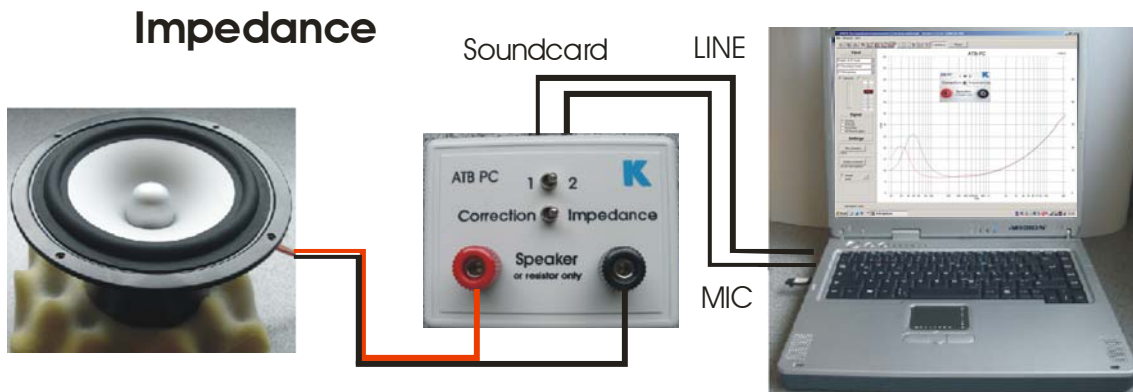
Menu from Setting for setting the measuring resistor R1.

The measuring resistor R1 is located at the headphone output. A  $1000\Omega$  resistor is recommended for the measurement. The resistor can also have a different value, but this must be entered in the Adapter menu during calibration. Other settings are not accepted.



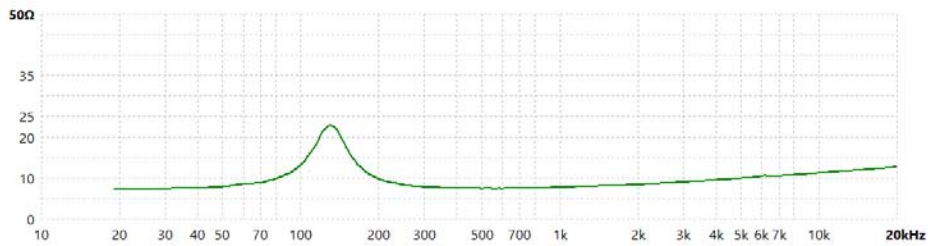
In dem Menü wird vor der Messung der Eingang gewählt. Neben dem Menü ist eine Anzeige für den Pegel. Die für die Impedanzmessung benötigten Einstellungen von Ein- und Ausgang wurden bei der Kalibrierung automatisch erstellt und benutzt.

Measurement setup with the simple ATB adapter

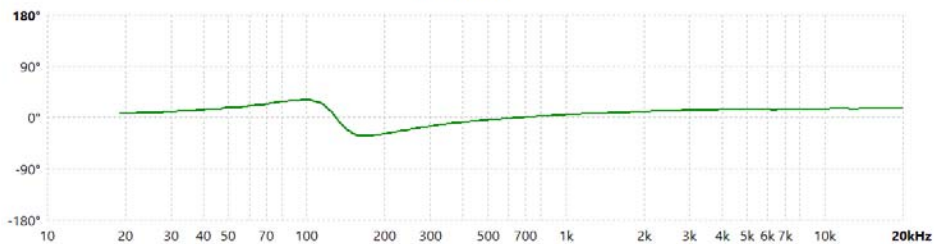


The buttons start the measurement.

Impedanzmesser



Impedanzmesser



The measurements show the impedance with magnitude and phase of a loudspeaker.

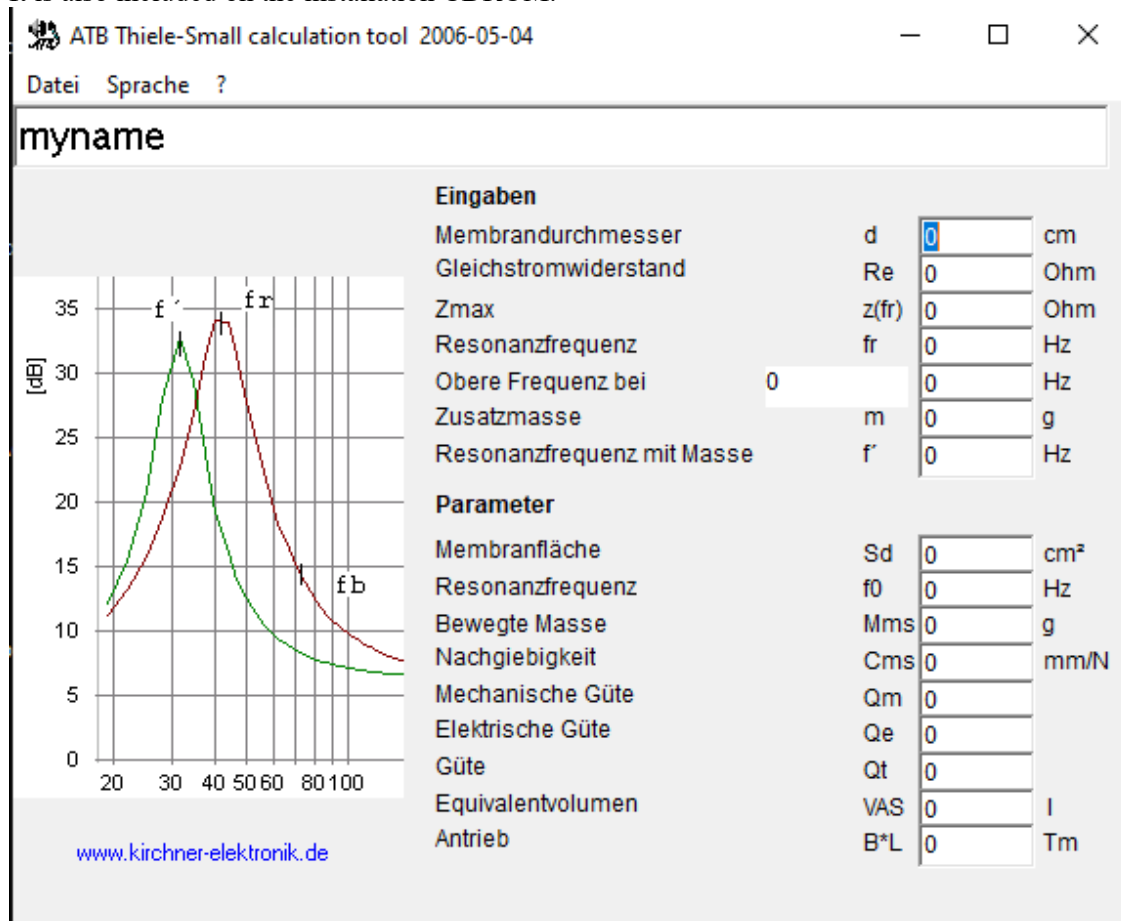
With the 2-channel adapter, the resistor is connected to IMP and switched to IMP.

Kirchner elektronik

## 11. THIELE-SMALL PARAMETER

ATB\_TS\_Tool.exe

The programme can be downloaded from the website [www.Kirchner-elektronik.de/download](http://www.Kirchner-elektronik.de/download). It is also included on the installation CDROM.



For the Thiele-Small Parameter measurement, the impedance of a single, uninstalled loudspeaker is measured twice. For the second measurement, an additional mass is attached to the membrane of the loudspeaker. The additional mass depends on the size of the loudspeaker.

Speaker diameter Additional mass

- 10cm 20g
- 15cm 30g
- 20cm 60g
- 25cm 100g

Depending on the design, the weight may differ. The decisive factor is that the maxima of the two impedance curves are 1.5 times apart.

With the values from the impedance measurements, the Thiele-Small parameters are calculated in an external programme.

**Kirchner elektronik**

## 12. SOUND PRESSOR LEVEL METER, SPL



The button calls up the programme.

The SPL frequency response measurement does not require a distance measurement because of the correlation function of the measuring programme.

The distance measurement must be carried out before the acoustic phase measurement.

As a measurement signal, ATB and sine sweep show an identical result.

The SPL measurement is an acoustic measurement.

According to the setting, three different measurements can be performed:

Amplitude frequency response

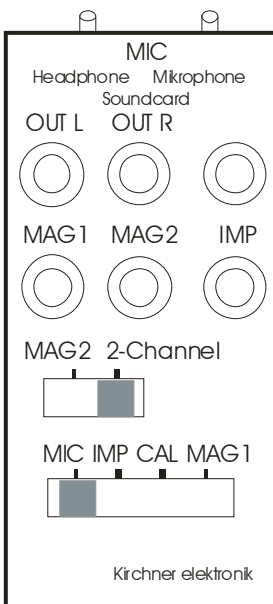
Phase frequency response

Real-time Analyzer

Spectrum Analyzer

A power amplifier is necessary for the loudspeaker measurement. Even simple hi-fi amplifiers are suitable. The amplifier is connected to OUT L. The calibration of the frequency response is taken over in the setting menu. The setting of the amplifier output voltage is measured with the Dem oscilloscope. For the measurement, a continuous measurement with a sine wave of 1 kHz is carried out.

The voltage at the loudspeaker output of the amplifier is measured. With the volume control a voltage of e.g. 4V is set and entered into the menu. In this way, the output voltage is set according to the controller in the programme.



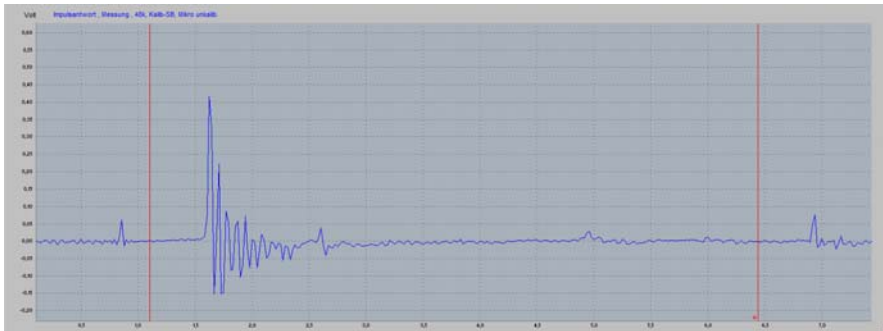
The amplifier is connected to OUT L and the measuring switch is set to MIC.

## 12.1 FREQUENCY RESPONSE MEASUREMENT

### Basics of frequency response measurement

The Sound Pressure Level measurement measures the frequency response of loudspeakers. It is indispensable for the development and evaluation of loudspeakers. Since the acoustic measurement depends on many factors, including the microphone and the room acoustics, an objective assessment is difficult. This circumstance is exploited by some developers and manufacturers who show embellished measurements, to say the least. That is why a linear frequency response does not indicate a good sound. Just as important for the sound is the time response. This is shown in the measurement of the step response and the acoustic phase measurement. Especially the acoustic phase cannot be measured by most measuring systems. Therefore, this important measurement has no significance for the developers.

In systems measuring with the Maximum Impulse Response, MLS, the evaluation of the sound by the frequency response is almost impossible. This is due to the division of the measurement into two ranges. The range up to 200Hz is measured with a high resolution. The range above 200Hz is measured with a narrow time window to eliminate room reflections. The measurement process starts with the impulse response.



This shows a reflection from the measuring room on the right. The theory is that the measurement can only be correct if the reflection does not falsify the measurement result. Therefore, the evaluation range for the FFT is chosen so that the reflection is outside. The evaluation range, the time window for the FFT calculation, lies between the two red lines.

With this time window, the programme shows an FFT with 256 points, 5.33ms time window length, distance of the points 187.5Hz, start frequency 187.5 Hz.



The frequency range from 200Hz to 1kHz is almost just a line. Investigations have shown that the smooth curves do not result from a fading out of connected for the curve, there is a strong smoothing.

**Kirchner elektronik**

However, this type of smoothing has the disadvantage that the accuracy of the FFT is greatly reduced due to the few points, supporting points. This is the usual measurement of a few magazines. Below 200Hz, measurements are then made in the near field with a higher resolution. Both curves are then put together the reflections, but from a strong smoothing. The measured amplitude values have a spacing of 187.5Hz. If these values are



32768 points, length of time window 682ms, smoothing 1/1 octave, spacing of points 1.46Hz.

An accurate measurement is achieved with the 32768 points FFT. The LMS measurement with the short time window is a fake. There are some loudspeaker designers who do not realise that the measurement is only for publication. The consequence is that due to the inaccurate measurement with three way speakers the transition from bass to midrange is not correct. This is clearly audible.

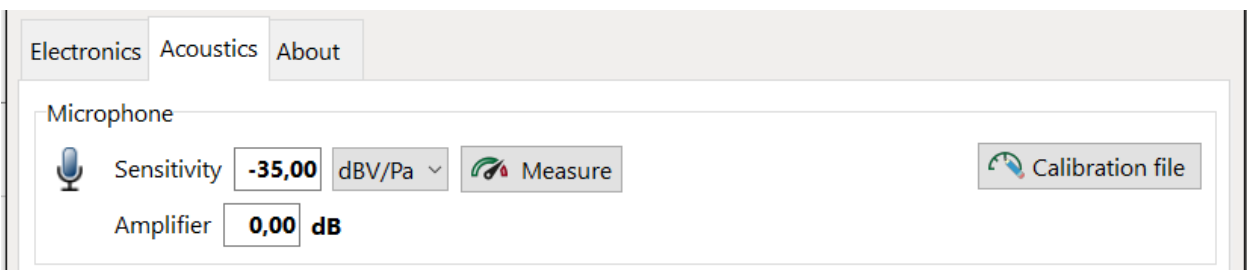
Therefore, the 32786 FFT is used for the ATB signal. The influence of the room on the measurement is mainly up to 300Hz. In this range the near field measurement is used.

The disadvantages of the MLS signal are low reproducibility, especially for low frequencies.

The ATB and MLS signal are described at the generator.

### The measurement microphone

A microphone is used for the SPL measurement. The accuracy of the measurement is determined by the microphone. Inexpensive measurement microphones do not have a linear frequency range. They are supplied with a calibration file. The file is saved under Setting on the acoustic card. The sensitivity of the microphone is also entered here. This is necessary for the standardised SPL measurement with 1W/1m.



### The standard SPL measurement

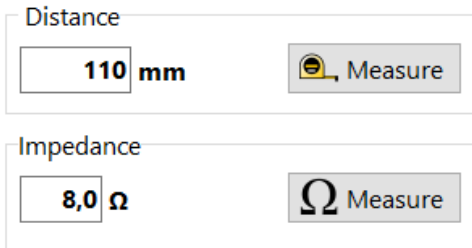
Kirchner elektronik

Attention: So that the SPL measurement shows the correct values. During calibration, the amplifier output is connected via the measuring adapter or the measuring box.  
 Make sure that the input of the soundcard is protected with the ZD diodes for overvoltage.  
 The amplifier output voltage is set to 4V during calibration.

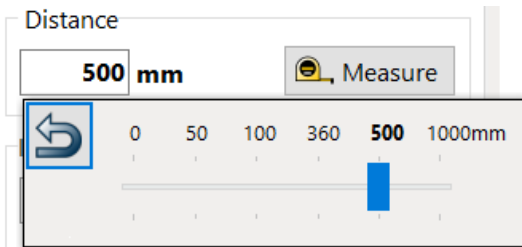
For the standard SPL measurement is supported by a special menu.

**Auto adjust**

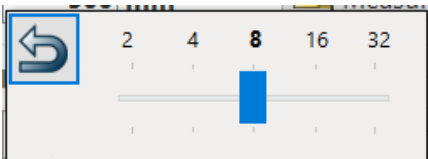
The function is activated with Auto Adjustment. The programme then automatically sets the output voltage of the generator according to the setting. Likewise, the sensitivity of the microphone and the settings are taken into account for the display of the measurement curve.



For the standard SPL measurement, the microphone distance, the distance and the impedance of the loudspeaker must be set.



The distance is set in the distance menu. This is measured with the folding rule from the front panel of the loudspeaker to the microphone capsule. The distance meter is of secondary importance here.



In the impedance menu, the loudspeaker impedance is set. The predefined standard values are selected here. The impedance measurement only gives an indication here. With a 4 Ω loudspeaker, the minimum impedance value is around 2.3 Ω. With an 8 Ω loudspeaker 6.2 Ω. Values in between are assigned to the nearest impedance value.

**Auto adjust**

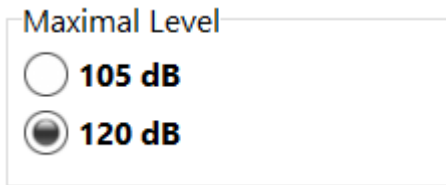
With this setting in Auto Adjustment, the output voltage for the generator can be set. This is advantageous for measurements where the standardised SPL measurement is not required. Für das Diagramm wird auf der Parameter Karte der maximale Wert für die dB Skala gewählt.

**Kirchner elektronik**

Attention:



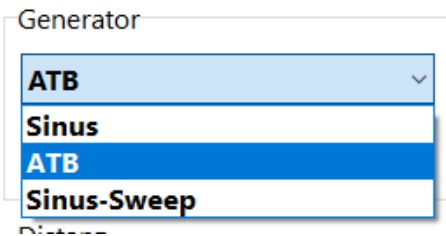
The level displayed depends on the microphone sensitivity set in the Setting, Acoustics tab. If the microphone cannot be calibrated, it will be changed in such a way that the curve shows the expected sound pressure (manufacturer's data).



In the parameters tab 105dB is selected for the HiFi speakers and 120dB for the sound reinforcement speakers.

Before the measurement, the smoothing factor, Smooth, is selected on the parameter card. Smoothing makes the frequency response clearer. For publications, the 1 octave value makes the curve completely smooth.

In the Generator menu we select the ATB or sine sweep signal.

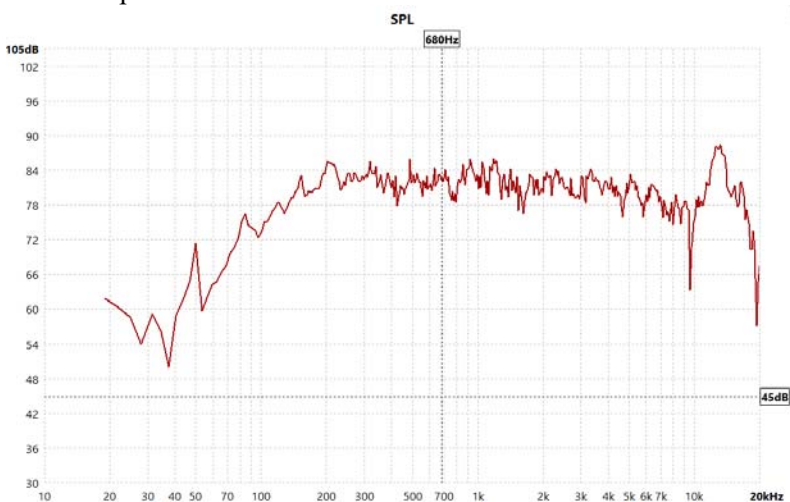


The measurement is started with the measurement buttons.

The buttons are Single measurement, Single measurement with display of previous measurements, Continuous measurement, Continuous measurement with display of previous measurements.



With the button, the continuous measurements are stopped after the measurement process has been completed.



**Kirchner elektronik**

The sound level meter has special functions on the data line card for processing the measurements.

With the setting ATB signal, the measurement signal can also come from a CD, DVD or as .wav from a USB stick.

This is very useful when calibrating the car sound system, as connecting the PC sound card to the car sound system can be very complicated.

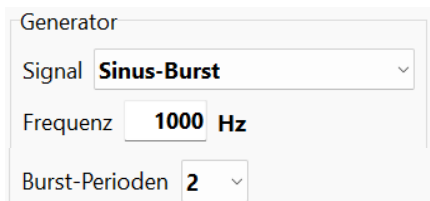
The Surround Test DVD can also be used to precisely adjust the system in the home cinema. Since the user can control the process, in contrast to the automatic calibration systems, a clear advantage can be achieved in the reproduction. This is not due to the inaccuracy of the automatic measurements, but to the algorithms for correction playback. These do not correspond to the listening experience.

## 12.2 ANECHOIC MEASUREMENT

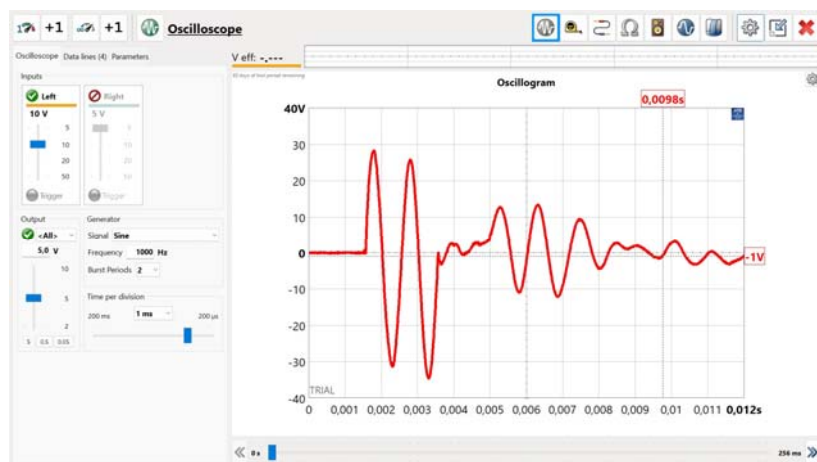
With the measurement, the quasi room-independent loudspeaker measurement is carried out.

For the calculation of the frequency response, a time window is set in which there are no reflections. For this purpose, the impulse response measurement is called first. The first reflection is shown in the measurement. The cursor is placed in front of it. After the return, the result is shown in the SPL menu.

the time until the first reflection can also be measured with the oscilloscope. The measurement signal in the generator is



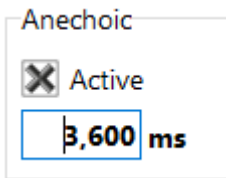
selected.



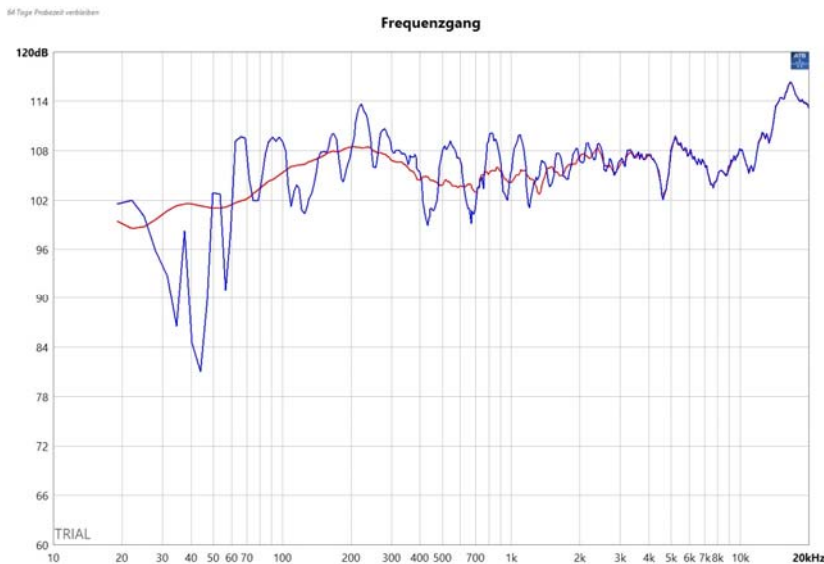
In the oscillogram, the measurement signal can be seen at the beginning. At 0.005ms the reflection appears.

To determine the length of the time window, the time from the beginning of the measurement signal, 0.0015 ms, is subtracted from the beginning of the reflection, 0.005 ms. The value for the time window is  $0.005 - 0.0015 = 0.0035$  ms.

This value is entered in the FFT menu.



For the anechoic measurement, tick Active under anechoic.  
For ms, the value determined in the oscilloscope is used.



The picture shows the usual measurement with the large time window, blue, and the measurement with the faded out reflections, red. It should be noted that with this value for the time window, the measurement is no longer correct for frequencies below 150 Hz. A near-field measurement is carried out for this frequency range. With the Combine function, this is combined with the anechoic measurement.



















## 12.3 SUM, COMBINE, IMPEDANCE

### Sum

For the summation of waveforms, the ATB Audio Analyzer program has one summation of amplitude and another of amplitude with phase. The two summations perform different measurements.



Addition of amplitudes, sound pressure levels of several measurements.  
This function is used to determine the sound field.

<input type="checkbox"/>		2020-03-25 11-47-46(#1)		
<input type="checkbox"/>		2020-03-25 12-11-34(#1)		
<input type="checkbox"/>		2020-03-25 12-11-55(#1)		
<input type="checkbox"/>		2020-03-25 12-12-20(#1)		
<input type="checkbox"/>		2020-03-25 12-12-49(#1)		
<input checked="" type="checkbox"/>		2020-03-25 12-12-57(Mitteln)		

The calculated curve is shown in the diagram after the summation.

### 1. Radiation pattern of a loudspeaker

Several frequency response measurements are made around the loudspeaker with different angles. The angles are chosen in vertical and horizontal alignment. Depending on the experience a fixed determination of the angles results. For a meaningful result 16 measurements are performed. When summing the curves, the sound pressure level is decisive. If the phase is included, the result is falsified. The resulting curve shows a drop for the high frequencies. However, it is decisive for the sound of the loudspeaker that the drop shows a balanced curve. Above peaks and dips in the falling curve show that the loudspeaker sound is very dependent on the room. If the drop is very even, so are the reflections of the room. Thus, the sound is less dependent on the room reflections.







### 2. measurements of the amplitude frequency response in a car

When measuring in a car, the frequency response is strongly dependent on the reflections. A measurement with one microphone position does not give an indication of the sound. Therefore, several measurements are made in the driver's head area. In this measurement only the level is important, the phase has no meaning here. The measurements are added and a faded frequency response is created, which corresponds to the sound. This frequency response can then be linearized by the equalizer if necessary.



The button calculates a new curve consisting of the sum of the measured curves. The amplitude and the phase are used for the summation. The curves are summed according to their time behavior.

This enables the correct tuning of bass reflex loudspeakers. It is also important for the development of transmissenline loudspeakers. Two measurements are made in the near field of the woofer and the bass reflex port.

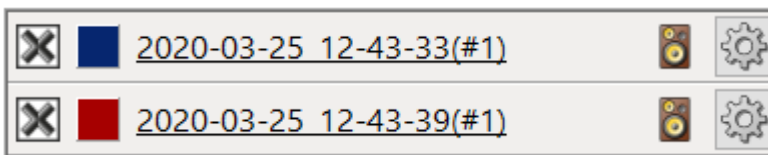
<input checked="" type="checkbox"/>		2020-03-25 12-43-33(#1)		
<input checked="" type="checkbox"/>		2020-03-25 12-43-39(#1)		

Here, the ratio of the area of the loudspeaker to the area of the bass reflex port is still important. Since the smaller area of the bass reflex port has a higher pressure, the ratio of speaker and bass reflex port area is calculated. The ratio is then converted to dB and the signal in the bass reflex measurement is reduced accordingly. The summation of the two measurements then gives the sound pressure radiated by the loudspeaker. This measurement is also independent of the room.

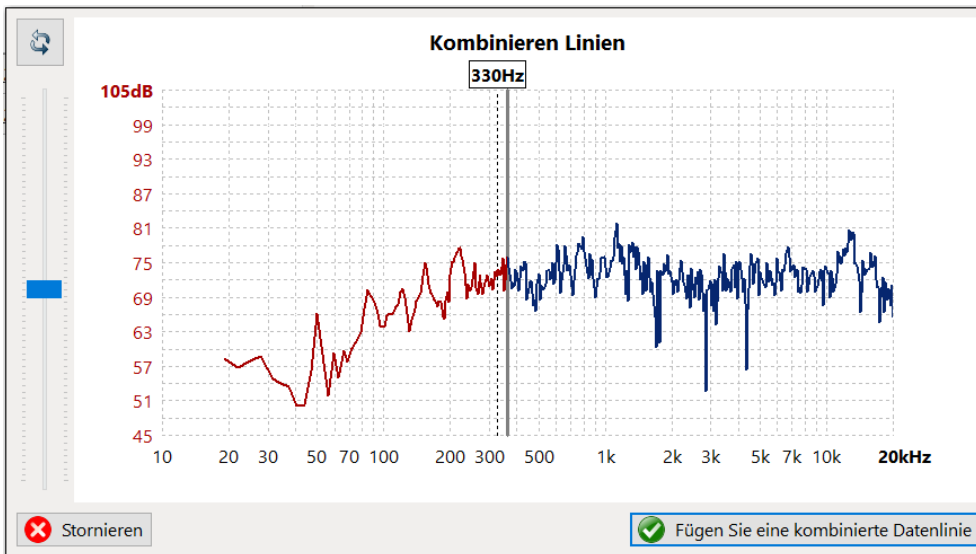
## Combine

The Combine function allows the loudspeaker to be measured according to the measurement in the anechoic chamber. It also replaces the measurement previously described in some journals in Basics of frequency response measurement. Since the transition from the near field measurement to the 1m distance measurement can be chosen for a higher frequency, the crucial reflections are faded out. This measurement does not have the poor resolution above 200Hz and thus results in a higher accuracy. For example, with a 3-way speaker the transition from bass to midrange is shown more clearly. The two speakers can be matched to each other much better.

For a room-independent measurement, the mid-high range of a loudspeaker is measured at a distance of 1m and the low-frequency range is measured with the sum function in the near field of the woofer and bass reflex port.

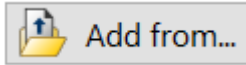


After measuring two curves, the button opens the combine lines menu

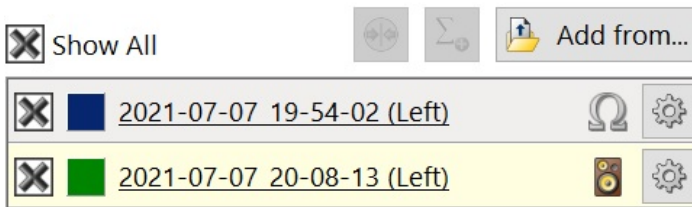
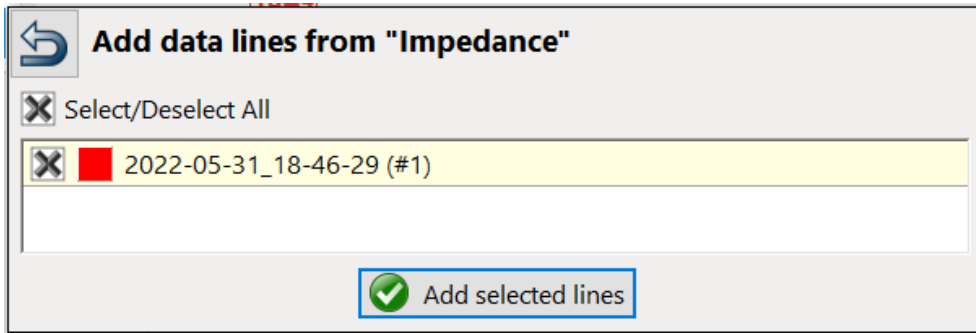


With the button the two curves can be swapped so that the near field measurement is on the left. The slider on the left adjusts the level of the left curve to the level of the right curve. The separating line between the curves is moved by touching or holding down the left mouse button. The separating frequency is selected so that a continuous curve is produced.

## Simultaneous display of SPL and impedance

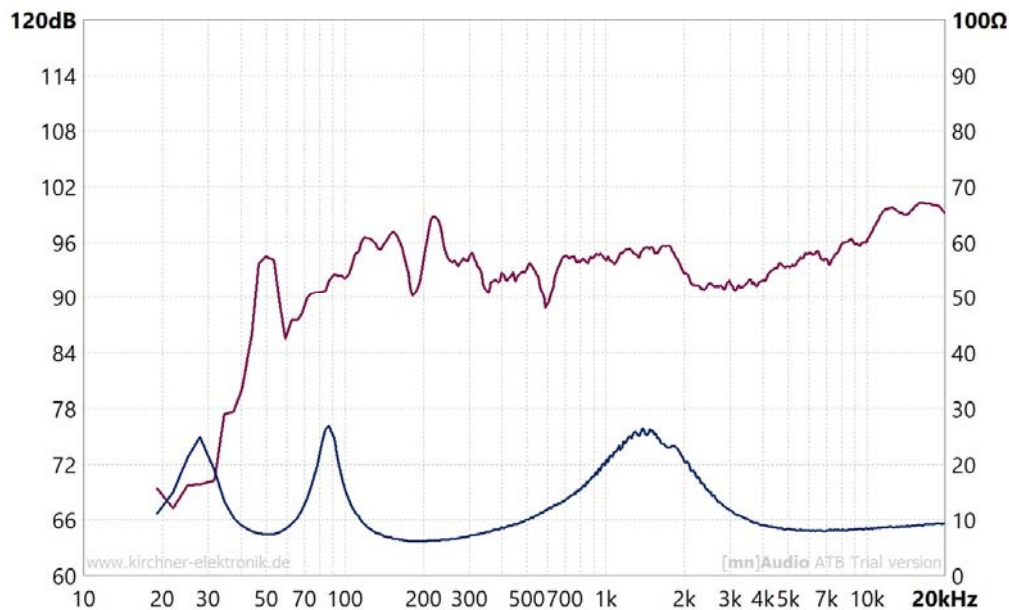


The button can also be used to insert an impedance measurement into the SPL diagram. The impedance curve is transferred to the data line menu and displayed in the diagram. The scaling in ohms is done on the right axis.



ver.1.0.1.166.D18

### Frequency Response



Kirchner elektronik

## 12.4 SMOOTHING

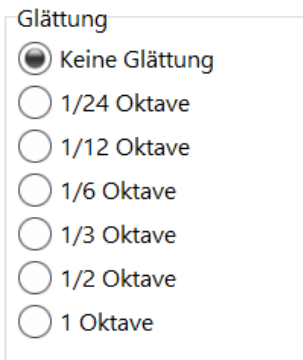
Acoustic measurements do not have the smooth frequency response of electrical measurements. This is due to the loudspeakers as well as room resonances and reflections. This irregular behaviour of the curve can sometimes obstruct the view of its essential characteristics. To get a smoother curve there is smoothing. With weak smoothing, no information is lost, the reproduction characteristics only become clearer.

With strong smoothing, transmission errors can be hidden.

The parameter smoothing determines the smoothing radius. This is the number of previous and subsequent measured values that are included in the calculation of the current display value. The setting range is set as an octave. In the case of a logarithmic frequency distribution, this results in constant smoothing over the frequency range.

The result of the smoothing function is a curve representation that corresponds to that of a sweep measurement, or the smoothing radius corresponds to the sweep range of the sine wave.

The smoothing is set on the parameter tab.



In the menu for smoothing, the smoothing radius is set.

The loudspeaker developer selects 1/24 octave. The ATB signal is then averaged over 3 measured values. For catalogues, 1 octave smoothing is often used, with an averaging of 38 measured values. These curves look nice, but have only a very limited meaning.

## 12.5 PHASE MEASUREMENT

Attention: Perform the distance measurement before the phase measurement.

The phase measurement shows the temporal assignment of the individual frequencies. This is determined by all circuits determining the frequency response. Acoustic phase measurement is not possible or very limited with most measuring systems. This applies to all systems that use the impulse response as a basis for calculation.

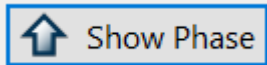
The sound and the spatial reproduction of loudspeakers are strongly determined by the acoustic phase. Therefore, the measurement is very important in loudspeaker design.

The measurement of the phase requires the adjustment of the distance. See the example of magnitude frequency response measurement. With the loudspeaker, the distance measurement is not always completely accurate. The measured value can be changed somewhat. Experience will show by how much. The goal is a phase representation in which the phase is straight over a wide range.

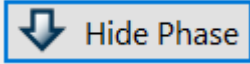
When measuring with a signal from the CD / DVD player, the phase measurement is not possible.

The reason for this is that the distance cannot be determined.

Phase measurement with a CD / DVD player is only possible with the ATB PC Pro by means of a very elaborate calculation.



The button opens the diagram for the phase.



The button closes the diagram.

## 12.6 LOUDSPEAKER MEASUREMENT TECHNOLOGY

When measuring the sound pressure frequency response of a loudspeaker, the measurement is influenced by the measuring room and the set-up. To eliminate the influence, measurements are taken in an anechoic chamber. For the development of individual drivers, the anechoic chamber is optimal. For the development of loudspeaker combinations, the speakers, tuning in an anechoic chamber leads to results that are far removed from practice.

The measurement in the anechoic chamber does not correspond to the listening result, because the loudspeaker is standing on the floor when listening and the woofer sees a different environment than in the anechoic chamber. The floor causes an increase of about 3dB for low frequencies. The only ideal measurement seems to be the free-field measurement. The loudspeaker is placed in the middle of a large area with at least 20m distance between the boundaries. The microphone distance is 1m. Disturbing factors during the measurement are wind and ambient noise.

To be able to judge the sound of a loudspeaker with the frequency response measurement, it is not sufficient to measure with a microphone position. The energy radiated by the loudspeaker is decisive. An even energy is necessary for a more neutral reproduction in rooms, so that the room reflections are even. If excessive frequency ranges are amplified by the reflections, the sound becomes unnatural.

The energy of the sound radiation is measured by frequency response measurements with many microphone positions. The positions form a circle around the loudspeaker. A suggestion is the circle with a diameter of 1.5m. The distance to the loudspeaker is then 1.2m and the angle 35°. The 8 measurements on the circle are supplemented by 3 measurements in front of the speaker with a distance of 1.2m. For the 3 measurements the position is in front of tweeter, midrange and bass. For two-way speakers, the position is in front of the tweeter, between the speakers and bass. A curve is generated with the Sum function on the data line map. This curve will slope towards the high frequencies. This cannot be avoided with a loudspeaker. It is important that the curve is even and does not show any peaks or dips.

### Near-field measurement

The near-field measurement of the loudspeaker takes advantage of the physical property of sound that the sound pressure decreases with distance. A measuring microphone is placed at a distance of 10 cm in front of the woofer. Here, the direct sound is many times greater than the reflected sound, so that only the direct sound is measured. This measurement is only carried out below 300Hz and supplemented by a measurement for the frequency range above 300Hz. The second measurement is taken at a distance of 1m to measure midrange and tweeter together.

In the near-field measurement, the sound from all sources in the low-frequency range must also be measured. These sound sources also include the midrange speaker if the crossover frequency is <300Hz. The measuring distance for the microphone is 10cm. Bass, bass reflex port and, if applicable, midrange are measured one after the other. For the bass reflex ports, the ratio of the woofer's diaphragm area and the port must be taken into account.



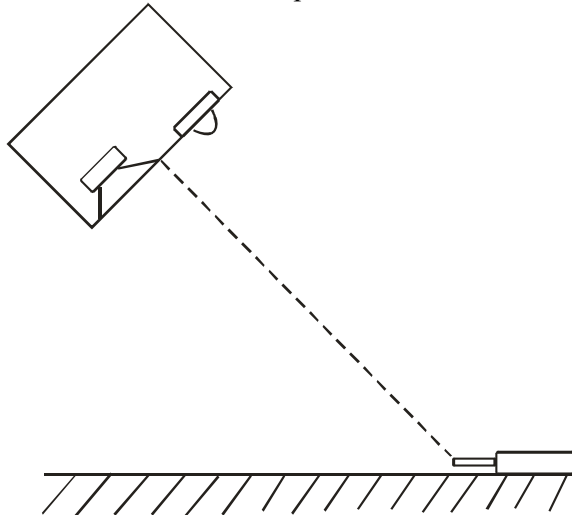
According to the formula

$$\text{pressure} \sim \text{force} \times \text{area}$$

an opening produces a higher pressure than the large area of the woofer. With the output control, the compensation can be adjusted by numerically entering the output level according to the area ratio. This way the low frequency range can be measured correctly.

### Limit area measurement

For limit area measurement, the measurement microphone is operated as a boundary microphone. The microphone lies flat on the floor and has a hemispherical characteristic.



The picture shows the arrangement of the loudspeaker and microphone. The sound waves of the loudspeaker hit the floor at an angle and are reflected into the room. This is particularly noticeable in the mid-high range. Also in the low-frequency range, where the room resonances develop, only half of their energy is picked up by the boundary layer microphone, so that they no longer affect the measurement so much.

Because of the room resonances, the following also applies here: the larger the measuring room, the better.

## 12.7 MEASUREMENTS IN THE CAR

In the car, it is usually complicated to feed the measurement signal into the system via a cable. If a CD drive is available, the Auto-Test CD can be played. The measurement signal can also be played as a WAV file from a USB stick.

## 12.8 REALTIME ANALYZER, RTA

For the real-time analyser, the measurement signal is set to sine.



On the parameter card, 1/3 octave is set under Smoothing for the third octave analyzer.

Smoothing

No smoothing

1/24 octave

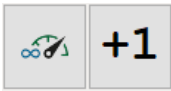
1/12 octave

1/6 octave

1/3 octave

1/2 octave

1 octave



The Real-time Analyzer is started with the buttons of the continuous measurement.



The button stops the measurements. In the case of continuous measurement, the current measurement is carried out before the stop.

## 12.9 SPEKTRUM ANALYZER

For the spectrum analyser, the measurement signal is set to sine.

Generator

Signal **Sinus** ▾

No smoothing is set on the parameter tab under Smoothing.

Smoothing

No smoothing

1/24 octave

The measurements are started using the familiar buttons.

### Spektrum Analyzer zur Aussteuerungs- Kontrolle

In the generator menu, the sine signal and the frequency are set.

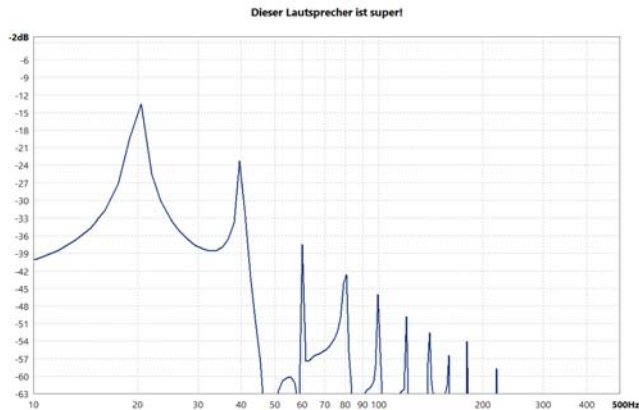
Generator

**Sinus** ▾

Sine Frequency  Hz

**Kirchner elektronik**

This measurement shows the overload, clipping, of the electronics. This is especially important for systems with DSP. The clipping cannot be heard directly, but it makes the sound unbearably hard. It often happens that certain settings lead to internal clipping. If the bass is strongly boosted, the measuring frequency 20Hz is used to check whether the computer is still within its value range. The settings for the input and output controls are also checked with the spectrum analyser.



The picture shows typical clipping.

The spectrum analysis can also be used to measure the linear range of a loudspeaker's excursion by measuring the impedance with a measuring resistor that is small compared to the loudspeaker's resistance.

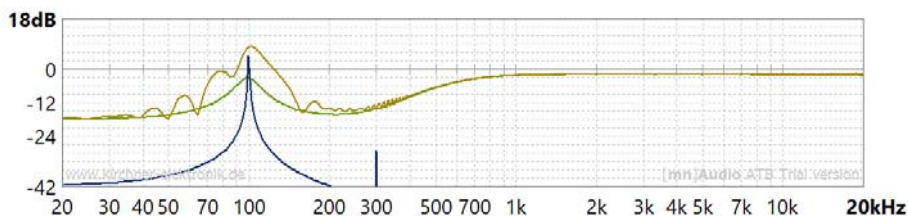
### Testing a DSP for digital overload

The value range of a DSP is limited. As a result, it happens that the programmed functions are not calculated correctly. This digital override generates new signals and distortion. Digital overdrive is particularly noticeable in the low frequency range. A powerful bass is expected especially in a car. So it is boosted in the DSP by the equaliser. Since the music played also contains very strong bass, the boost can push the value range of the DSP to the limit. Therefore, it is very important to select the input voltage so that this limit is not reached. If the input voltage is attenuated too much, the DSP only calculates with small values and the sound suffers.

The ATB Audio Analyzer measuring programme offers two measuring functions for setting the input voltage. Measurements are taken electrically at the DSP output with the magnitude measurement. The channel with a strong boost is connected, here for the woofer. The output signal is adjusted so that the sound card input is not overdriven. The test adapter or the test box is used for the connection.

ver.1.06.118

### digitale Übersteuerung vom DSP



1. The green curve shows the frequency response of the set function without overdrive.
2. The blue curve shows the spectrum analyser measurement with the sine wave. The frequency of the max. boost is selected. At 300Hz the distortion factor caused by the overdrive can be seen. The yellow curve shows the overload in the sine sweep measurement. Here you can see that frequency response is destroyed by the digital overload.

Kirchner elektronik

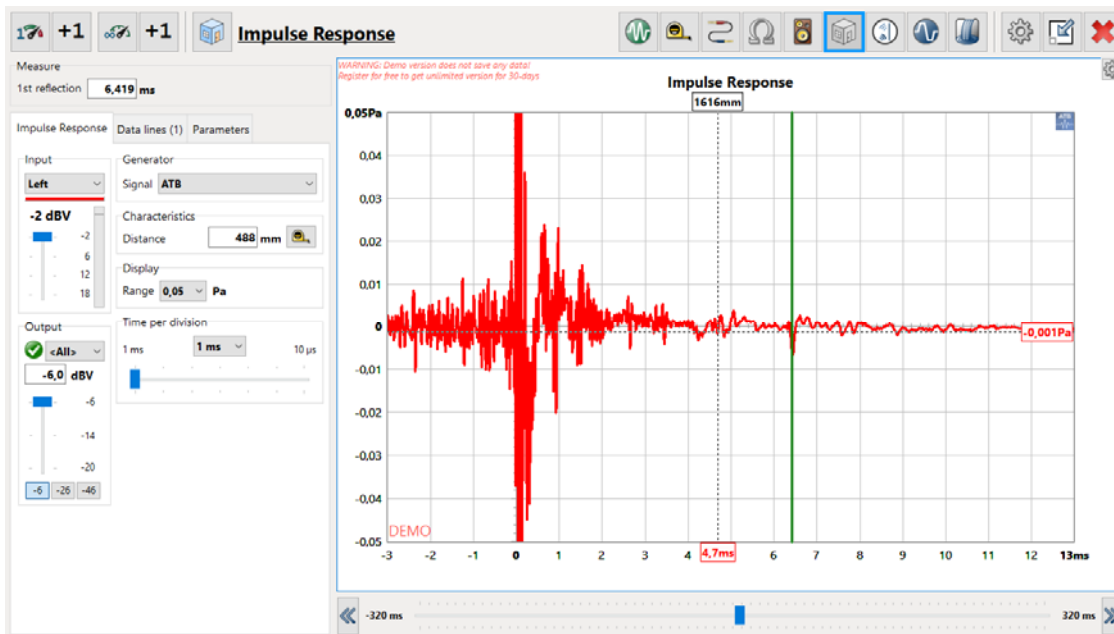
### 13. IMPULS RESPONSE



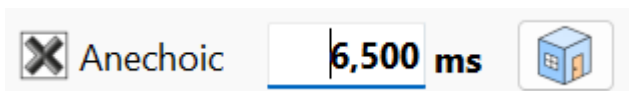
This button opens the measurement

The impulse response measurement shows the output signal of a transmission line, filter or loudspeaker. As input signal, test signal, the Dirac impulse is taken. The Dirac impulse has the amplitude 1 in mathematics and has a length that goes towards 0. Since this signal is a mathematical quantity, it cannot be used directly for the measuring technique. Therefore a pulse train LMS or the sine sweep is taken as measuring signal. These signals are used with the mathematical function of convolution for the calculation of the impulse response. The impulse response shown in the measurement is again a mathematical quantity. In it, the behavior of the transmission path can hardly be recognized. Only by the calculation of the step response the characteristics of the transmission line become recognizable. If the impulse response is calculated with the FFT, the amplitude and phase frequency response of the transmission line is obtained.

In the ATB Audio Analyzer program, the impulse response measurement is used to detect the room reflections. This is necessary for the quasi reflection-free room measurement.



In the SPL measurement it is set in the following menu.



The execution of the anechoic measurement is described in the SPL measurement.

**Kirchner elektronik**

## 14. TOTAL HARMONIC DISTORTION, THD



Press the button to open the Total Harmonic Distortion measurement.

In the Total Harmonic Distortion measurement, the sine signal is used. The sine is generated for discrete frequencies by the generator and analysed by the programme. The distortion components, harmonics, K2, K3, K4, K5 are calculated. These can be displayed individually or as a THD value.

The following settings exist


Generator

Frequency  —

Frequency steps

In the generator menu, the number of sine oscillations to be measured with continuous frequency is set under Points. For Start frequency and End frequency, the frequency range for the measurements.






Display

THD  K2..K5 

Range  %

In the display menu, the representation of the distortions in the diagram is selected. For distortion factor the THD value and K2...K5 the harmonics.

Legend

K2  K3  K4  K5  

On the parameter map, the colour assignment of the harmonics is shown in the Legend menu.

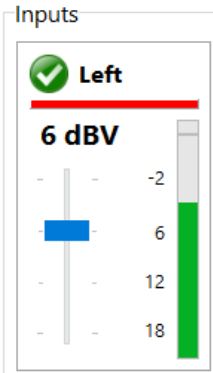


The button starts the measuring process for the first measurement and the additional measurement.

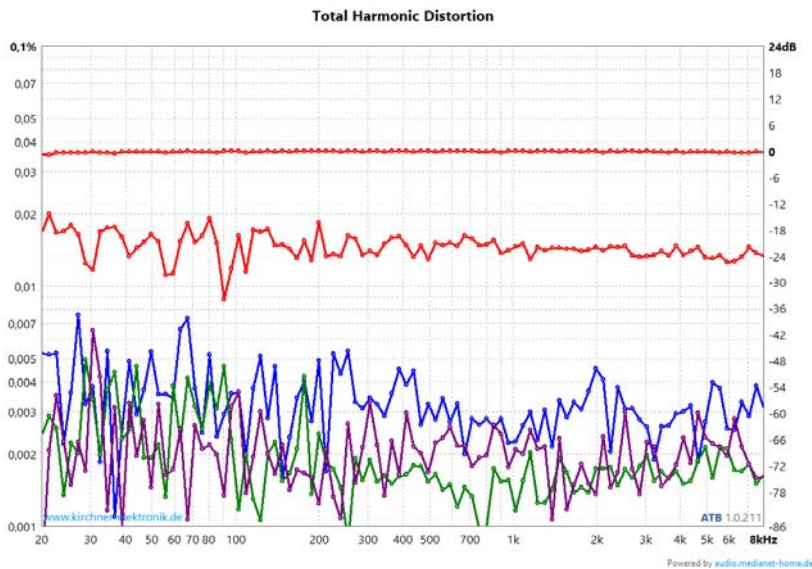


The button can be used to interrupt the measurement.

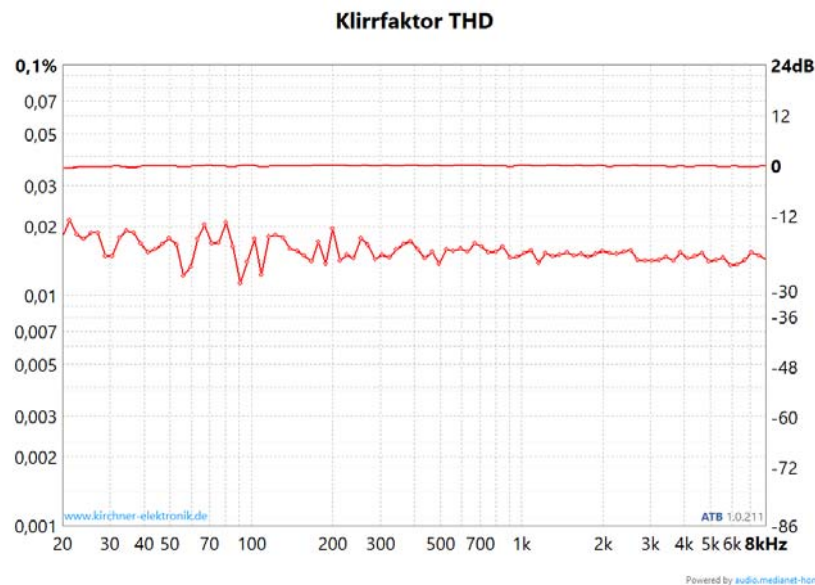
The input level indicator has a very important function in the measurement.



The bar must be green for a correct measurement. If it is red, the input is overloaded. If the green bar is only a small height, the measurement will be inaccurate.



The harmonics K1 to K5. The upper curve shows the amplitude of the input signal



The total harmonic distortion THD. The upper curve shows the amplitude of the input signal

## 15. WATERFALL, DECAY SPECTRUM



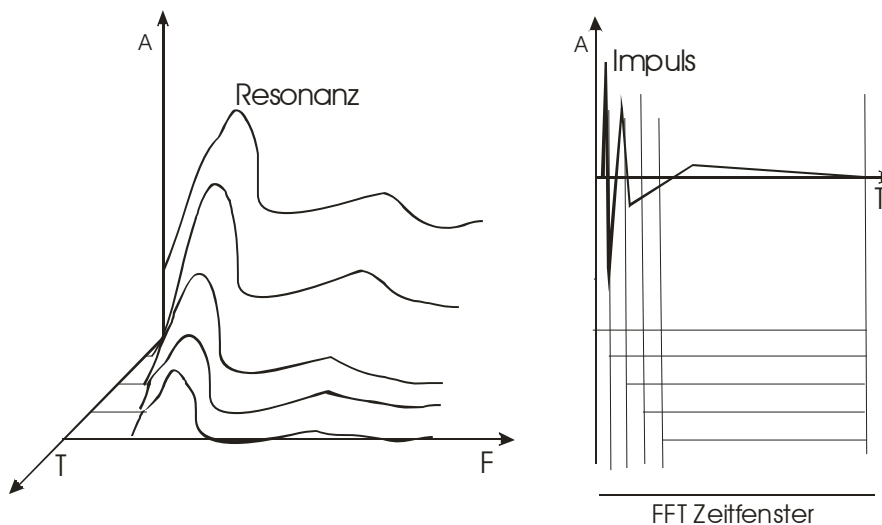
The button calls up the waterfall measurement.

### 15.1 BASICS

#### The waterfall measurement with the FFT

There are different methods of waterfall, decay spectrum, measurement.

The best known is the measurement with the FFT calculation. The maximum length sequence, MLS, or the sine sweep is used as the measurement signal. The basis for the measurement is the pulse. Frequency responses are calculated from the pulse with the FFT for different time ranges. The calculated frequency responses are assembled in the 3-D graph.



The picture shows how the decay spectrum is created with the FFT evaluations. The impulse response is shown on the right. The vertical lines show the limit of the value range for the FFT calculation. The decreasing value range is shown by the right horizontal lines. The left area without a line is filled with zeros. If the lines are extended to the 3-D diagram, a point on the time axis is determined. A curve is shown for the point on the time axis, which should show the oscillation of the loudspeaker. At time 0, with values for the whole time window, the frequency response is shown. It is physically impossible for the loudspeaker to reproduce all oscillations over its frequency range immediately with the measurement signal. Every vibration has a transient response. Not even the loudspeaker, which also has time delays during excitation. This is shown by the acoustic phase measurement. The picture where the entire frequency response is currently 0 has burnt itself into the minds of many developers. They do not understand the transient response and the phase behaviour. The loudspeaker transmits everything immediately at time 0. They also overlook the fact that the same impulse is always evaluated. For example, peaks and dips in the frequency response, which are caused by temporal processes, are not shown. It cannot be seen that a tweeter with a different time response to the midrange driver cancels out the midrange driver in the transition area. Nor is the temporal behaviour of filters set in the DSP to be seen.

**Kirchner elektronik**

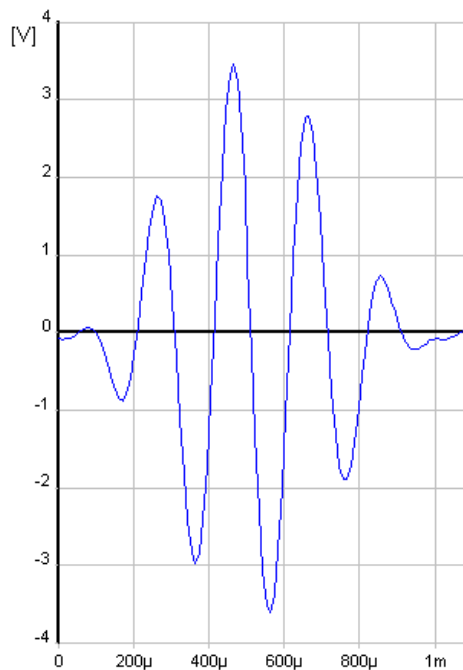
The only thing that can be seen is that a resonance is resonating. The resonance can also be seen in the frequency response. By its height and width, the quality can be sufficiently recognised.

The FFT decay spectrum is completely unsuitable for investigating the acoustic parameters of the room, as it is not possible to distinguish between the resonance of the loudspeaker and room reflections.

### The waterfall measurement with the cosine burst

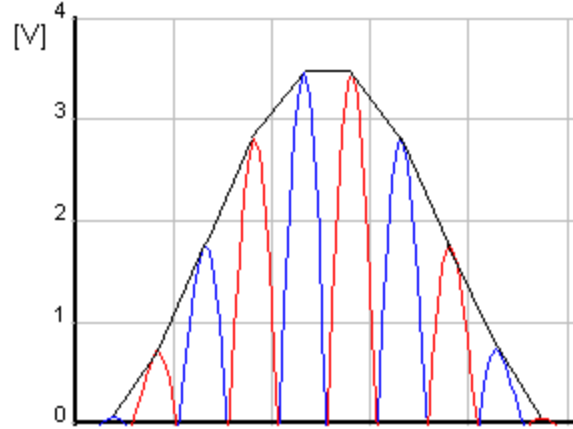
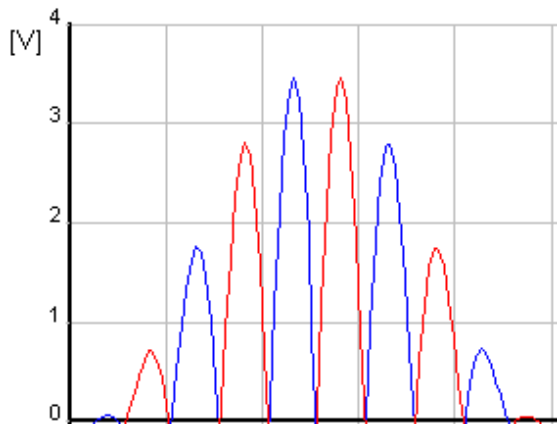
The basic consideration for the ATB measurement of the decay spectrum was to avoid complex mathematical procedures. The measurement method falls back on the simple oscilloscope measurement. For each frequency, an oscillogram is created and displayed as a mountain in the waterfall diagram. The single oscilloscope image is measured with the cosine burst as the generator signal. The cosine burst consists of 5 sine oscillations that have been converted to the cosine burst with a mathematical window. The cosine burst only contains one frequency. Therefore, it can be used to investigate the oscillation and decay behaviour at this particular frequency.

### THE WAY FROM THE OSCILLOSCOPE TO THE DECAY SPECTRUM



After measuring the oscillogram with exact temporal assignment of generator and measuring signal, the measuring signal is rectified.

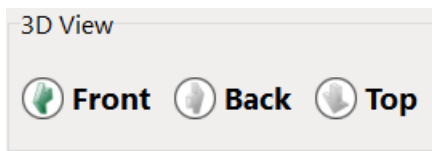




The rectified signal is converted to an envelope curve with a digital filter. The amplitude values are logarithmised for the display.

The individual envelopes are displayed in the decay spectrum. Each envelope curve shows the temporal behaviour for one frequency.

In the waterfall diagram, the points of the same time (period) are connected with lines.



In the menu above the graphic, you can choose between decay (front) and decay (back). Front because of the usual representation of the FFT decay spectrum.

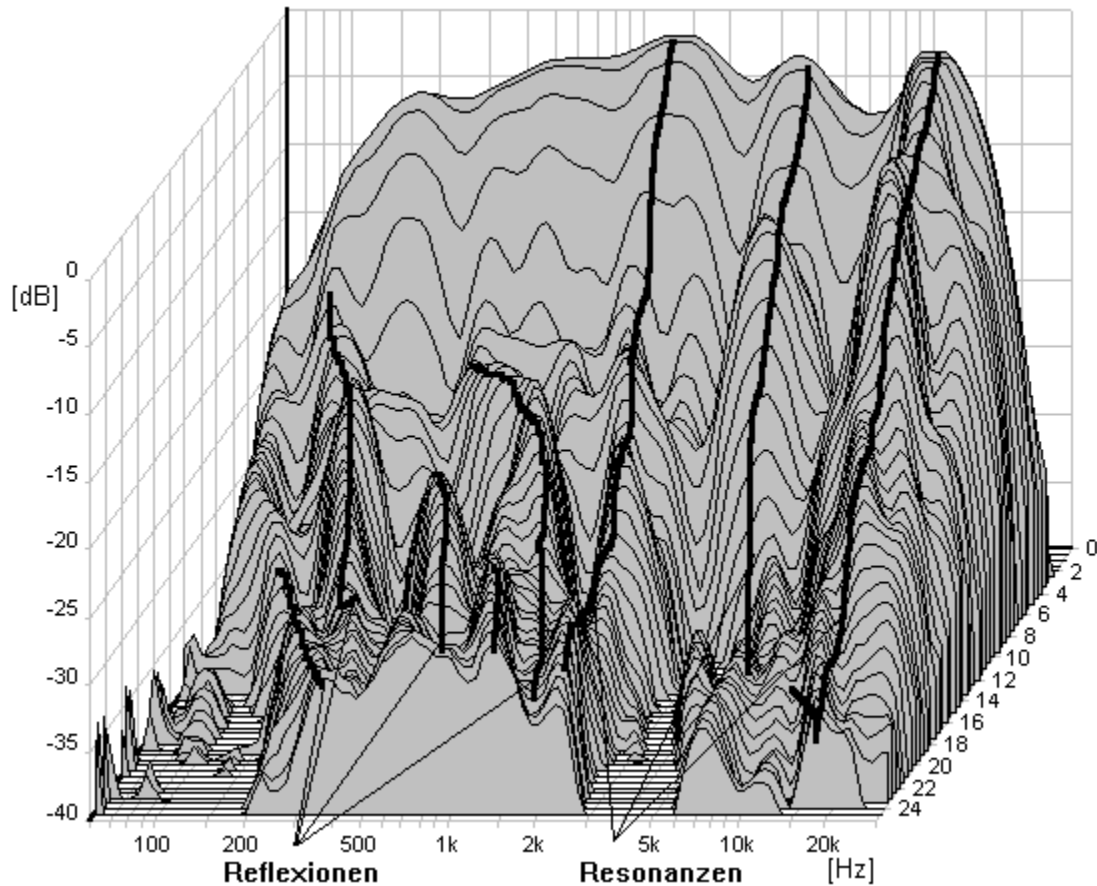
This Top button calls up a 2D view. This corresponds to the wavelet display.

### Decay behaviour

When measuring the decay behaviour, the cosine burst is used as the generator signal. After displaying the envelope diagram, the waterfall diagram is created on the screen. The lines running from right to left show the amplitude values of the same period. These periods correspond to a normalised time axis. By normalising the time axis, it is possible to display the entire audio range in one diagram. The time T for the individual frequency f is given by

$$T = (1/f) \times \text{period.}$$

## Interpretation of the waterfall diagram



By scaling the time axis in periods, a distinction between reflections and resonances becomes possible. Resonances create a mountain range in the direction of the time (period) axis. A reflection is represented as a mountain range running to the right (curved). Reflections have a constant delay compared to the direct signal. This delay time is formed in the waterfall diagram with a time axis in a mountain range parallel to the frequency axis. With the period axis, the mountain range is no longer parallel, as the representation is frequency-dependent. At low frequencies, the constant time is represented by a short distance, and at higher frequencies by a longer distance. Thus, a reflection can be seen on a mountain range running from the rear left to the front right, which is curved because of the logarithmic frequency distribution.

## Transient behaviour

By changing the sign of the time (period) axis, the transmission behaviour, which is concealed by the mountain during the decay, becomes visible. The importance of this measurement is shown by the examination of music signals as well as the hearing process in humans.

When observing music signals, it is noticeable that music is composed of individual impulses. The individual impulse consists of a fundamental tone with numerous overtones. The overtones cause the impulse to rise steeply. The fall is gentler as the tones decay. The exact reproduction of the rise is crucial for the transmission of the characteristics of musical signals. The importance of the decay is decidedly less. This is shown by the sound reproduction of horn loudspeakers.

**Kirchner elektronik**

These loudspeakers have a very good transient response. Their sound is perceived as natural by sound engineers and musicians, although the frequency response is not particularly linear and the decay is relatively poor.

If a transmission path is to be examined for its properties in the transmission of music signals, this is most meaningful with impulses corresponding to the music.

The necessity of examining the rise and delay of an impulse is shown by looking at the hearing process. In humans, the first impulse received by the ear is particularly evaluated by the brain. It contains the information for directional hearing. Only if the temporal allocation of the tones is correct, a music reproduction is perceived as spatial.

If the transient behaviour is measured with the cosine burst signal, it is shown how the transmission path reaches its steady state. The phase behaviour and the running time can be seen in the waterfall diagram. An optimal transient response shows an even rise of the mountain, the amplitudes of the lines of the same period (normalised time) run parallel.

## 15.2 MEASUREMENT

Attention:

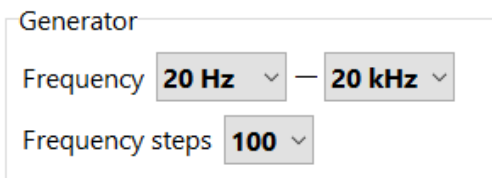
All measurements start with the distance measurement. The electrical measurement is also measurement to take into account the time behaviour of the Windows programme.  
time behaviour of the Windows programme.



Distance

500 mm Measure

In the menu, the distance from the loudspeaker to the microphone is set. When measuring with the distance meter, the value is taken over. Since the waterfall diagram is a temporal measurement, the time of flight of the sound must be taken into account.



Generator

Frequency 20 Hz — 20 kHz

Frequency steps 100

In the generator menu, the scaling of the y-axis is set under Range. With Start frequency and End frequency the frequency range of the measurement is set. The frequency step setting determines the number of the points to be measured.



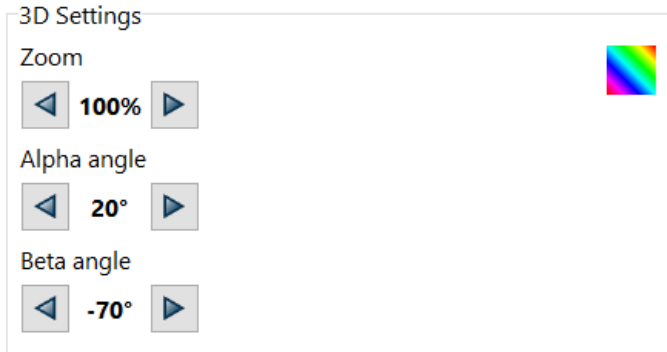
Display

Range 45 dB

# of periods 10

In the menu, # of the lines determines the  $\frac{1}{2}$  number of periods for the display of the measurement period.

### Settings on the parameters tab

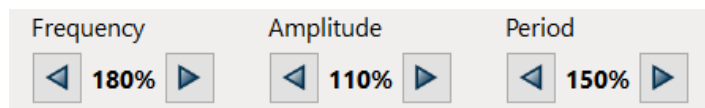


In the menu, the display of the 3D diagram can be set.

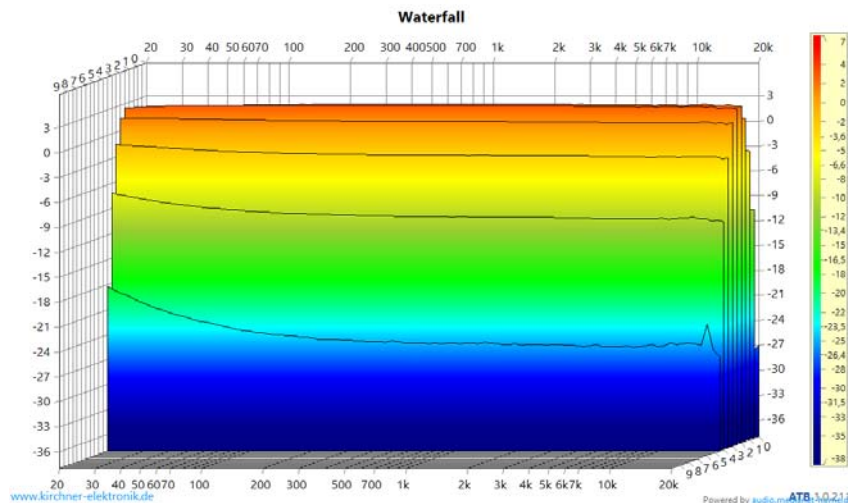


This button on the parameter card can be used to switch from multi-colour to single-colour for the trace.

### Diagram settings



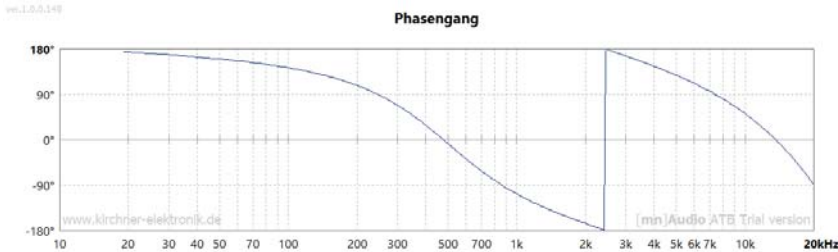
The buttons can be used to adjust the length of the axes of the 3-D graphic.



The measurement shows the measurement signal for the decay spectrum. For the measurement, the headphone output was connected to the microphone input via the adapter. The sample frequency is 192 kHz.

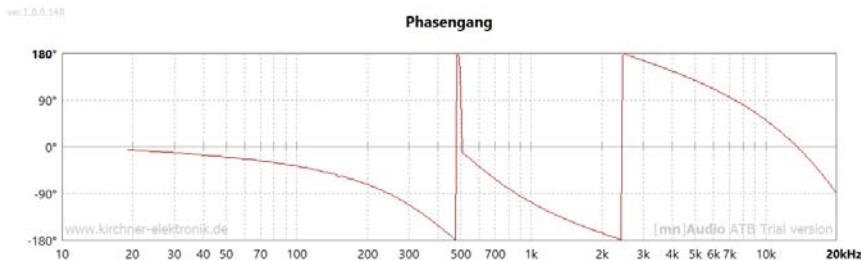
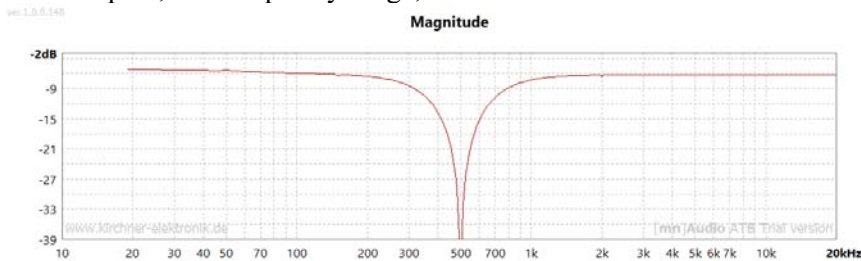
Waterfall measurement of a Linkwitz 2-way crossover with 500Hz crossover frequency, 24dB/octave.

The crossover is set in a DSP and the outputs for the low and high frequency range are combined with an analogue addition circuit.

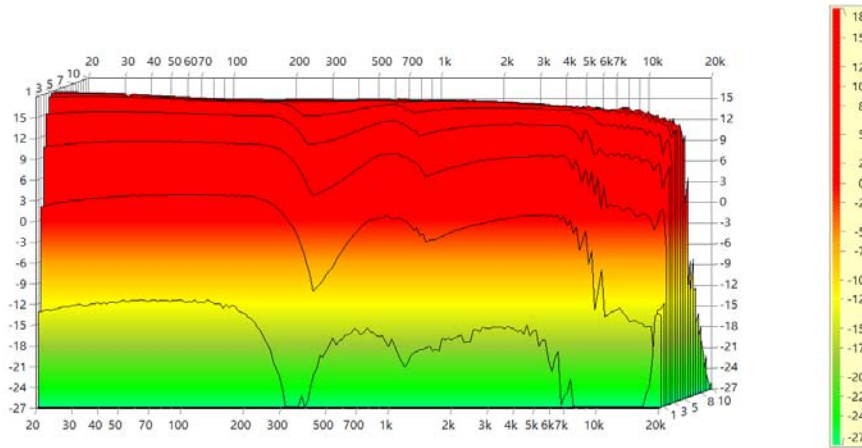


The crossover's frequency response is very linear. The crossover frequency is no longer visible. The phase shows the expected phase rotation of  $8 \times 90^\circ = 720^\circ$ . When the curve reaches the  $-180^\circ$  line, there is a jump to the  $180^\circ$  line to continue the curve. This is determined by the graphical representation in the range from  $180^\circ$  to  $-180^\circ$ .

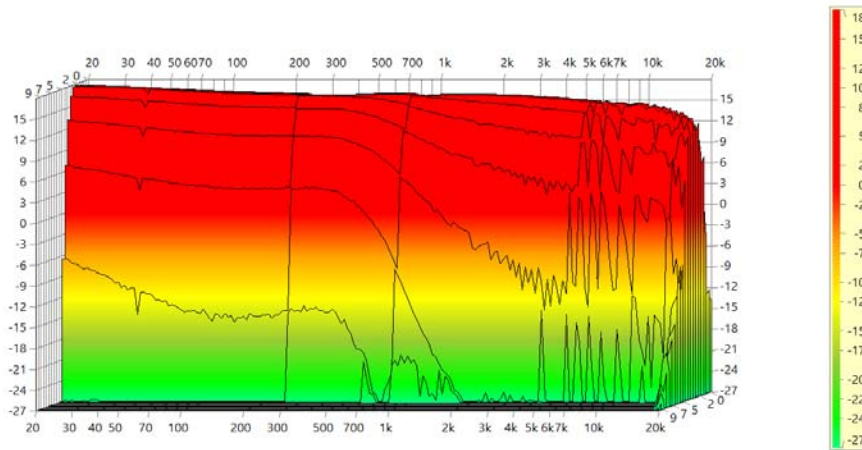
The low pass, low frequency range, inverted



When a channel is inverted, the dip in the frequency curve occurs. At the same time, the wrong polarity in the phase measurement is shown by the jump in the crossover frequency. For loudspeakers, this is the decisive measurement for the correct polarity.



With the waterfall measurement, the transient behaviour is shown. This enables the cosine burst measurement. Contrary to the frequency response measurement, where the circuit is steady, the measurement shows a dip at the crossover frequency of 500Hz. Only after 2.5 periods the balanced frequency response is shown. In this range the signal is delayed. The delay of a frequency range disturbs the temporal relationship between fundamental and overtones in instruments. How far this can be heard would have to be investigated. If there is a time delay, the area that is missing during the transient will appear as a mountain during the decay. The measurement of the decay behaviour shows no additional signal at the crossover frequency. Only the delay due to the large phase rotation for high frequencies can be seen.



Decay behaviour of the Linkwitz filters. Because the frequency components missing during transient oscillation are not replaced during decay, they are missing during transmission. This greatly alters the sound. This effect that frequency components are missing due to the crossover, can also be explained mathematically.

## 16. REVERBIRATION TIME

In room acoustics, the acoustic properties of a room are determined by the reverberation time. The reverberation time shows the time in which the reflections in a room have decayed. Depending on the use of the room, specific reverberation times are required. These are achieved by structural measures and damping of the room. In a recording studio, this time is particularly short, since the reflections should not influence the recording during mixing. However, if music is heard in this room, the sound is not perceived as pleasant. In living rooms, the reverberation time should be longer so that the room reflections complement the music. In conference rooms or classrooms, the reverberation time should be selected so that the reflections make the voices sound somewhat fuller. If the reverberation time is too long, the intelligibility of speech will be disturbed by the reflections.

The task of the acoustician is to adjust the reverberation time to the use of the room. For this he needs the reverberation time measurement.

The reverberation time measurement is precisely defined in the DIN, ISO. The ATB Audio Analyzer reverberation time measurement measures according to the standard. In contrast, non-professional programs calculate the reverberation time from the impulse response. These show the correct result only in theory.

To be able to determine the reverberation, a short sound event (a tone) is sent in all directions of the room with a centrally placed loudspeaker during an acoustic measurement. Once the event is over, one measures how long this sound lingers.

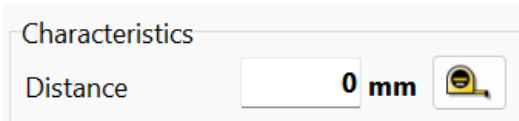
To be able to determine the reverberation, an acoustic measurement involves sending a short sound event (a tone) in all directions of the room with a centrally placed loudspeaker. Once the event is over, the duration of the reverberation is measured.

For the short sound event, the sine sweep is used. It is a very short sweep, specially designed for measurement. Another signal is the impulse, but it is best generated by a bang. The signal is not suitable for a loudspeaker. Another signal is the LMS noise. This allows accurate measurements, but requires high volumes. With the sinus sweep, these high levels are not necessary. The omnidirectional loudspeaker can also be replaced by a sound reinforcement loudspeaker. Then this is set up at different positions in the room. Up to 8 measurements are performed. The measurements with different placement of the loudspeaker and microphone are averaged. This allows the measurement without the special loudspeaker.

### 16.1 THE MEASUREMENT



The reverberation time measurement is called up with the sound button.



The button showing the measuring tape is used to call up the distance measurement. After the return, this is entered in the menu.

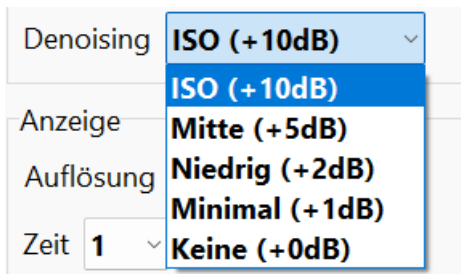
The distance must be measured again for each new loudspeaker microphone position.

For the measurement, the distance of interfering noise to the brass is decisive. With the SPL measurement a measurement without connected loudspeaker is carried out. This shows the noise.

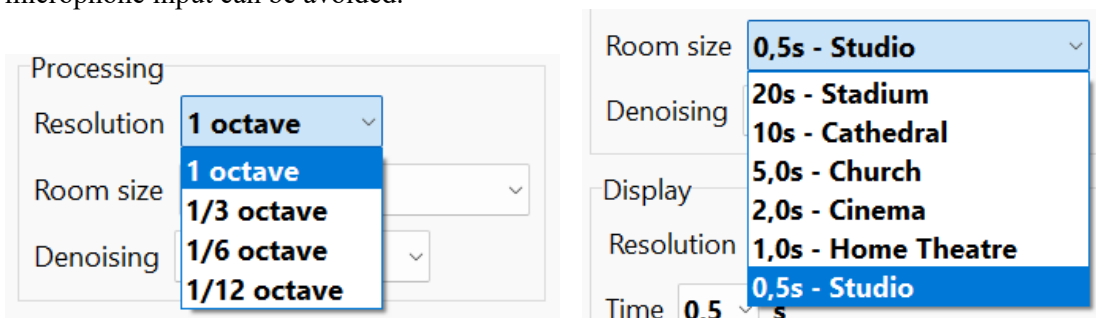
Another measurement is performed with the brass. Here, the volume is increased until the distance from the noise to the curve with signal is 60db. The 60db is the optimal value.

**Kirchner elektronik**

If the volume, which is felt to be too high for the loudspeaker at an interference signal distance of 60dB, the volume can be reduced by 10dB. The denoising menu helps here.



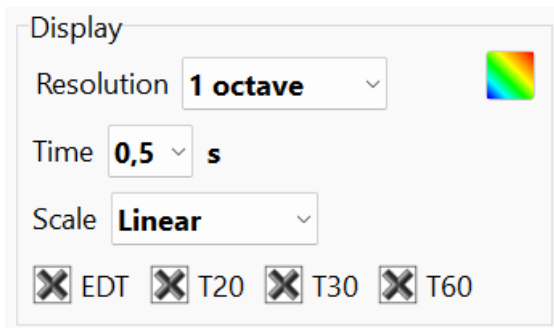
For DIN, ISO measurement, ISO (+10dB) is selected according to the regulations with the interference voltage distance of 60dB. With the level reduced by 5dB, center (+5dB) is selected. This setting is also recommended in the living rooms, as overdriving of the microphone input can be avoided.



As further settings, the frequency range for the filters in the frequency curve can be set under Resolution. Common is 1 octave and 1/3 octave. With 1/12 octave the frequency of a reflection can be detected. In the room size menu the measuring time is adapted to the room size. To keep this short, the corresponding room is selected.

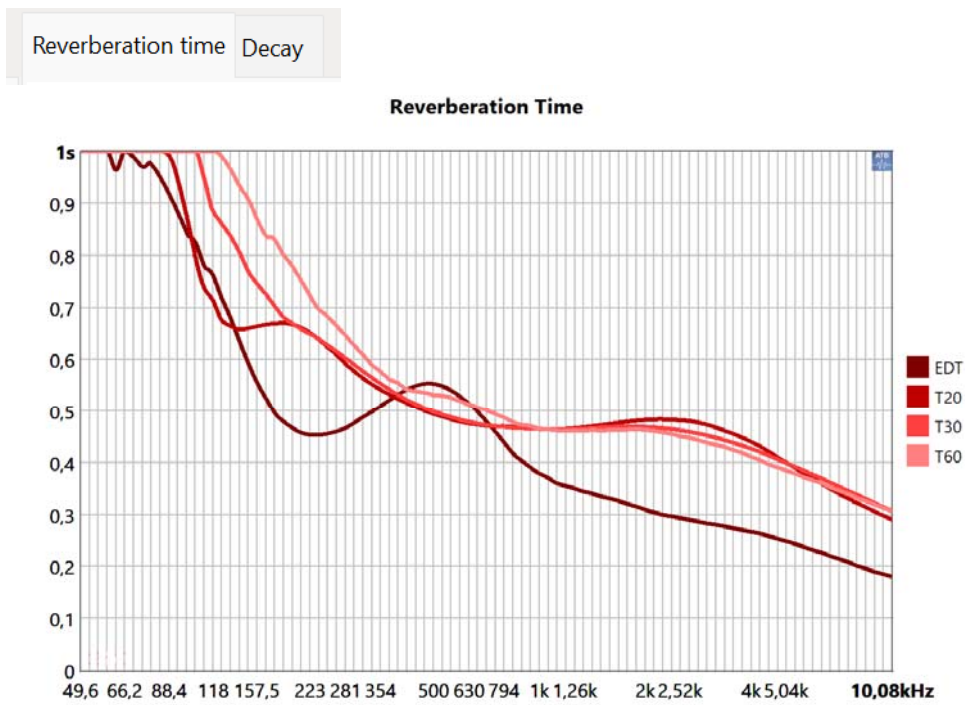
During the measurement, the approx. 8 measurements with the different loudspeaker - microphone positions are checked to see if the measurements are similar. If the measurement is very different from the other measurements, it is an outlier. The measurement is deleted. In the data lines menu the curves are averaged.

The result can be adjusted in the display menu.

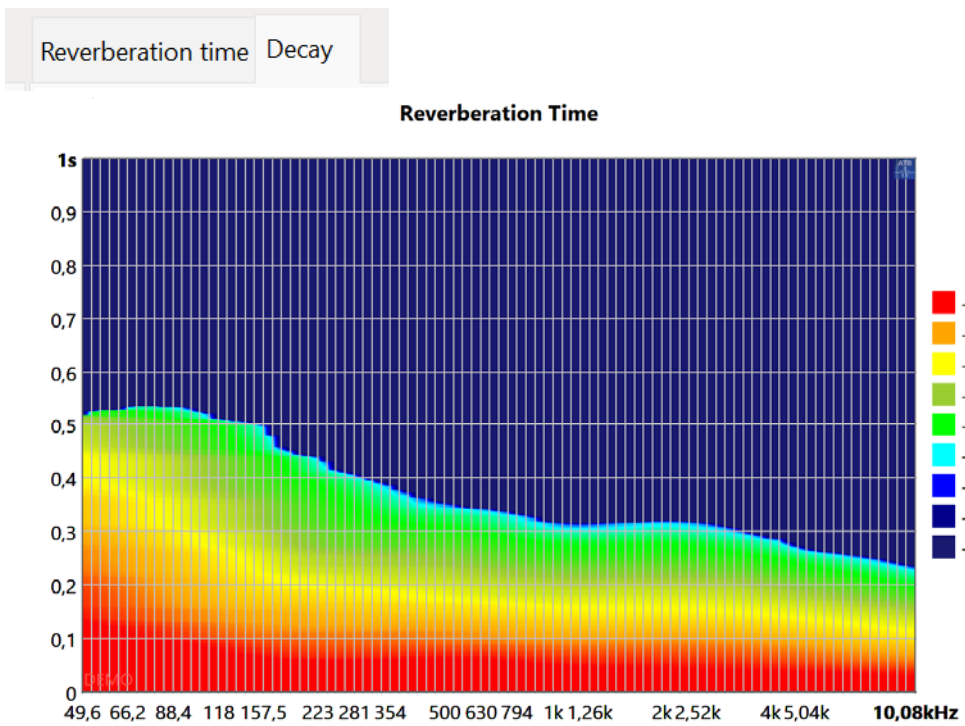




The measurement result is shown as frequency response over time.



Another representation of the measurement is the decay spectrum. It shows the decay of the reflections for the frequency ranges.



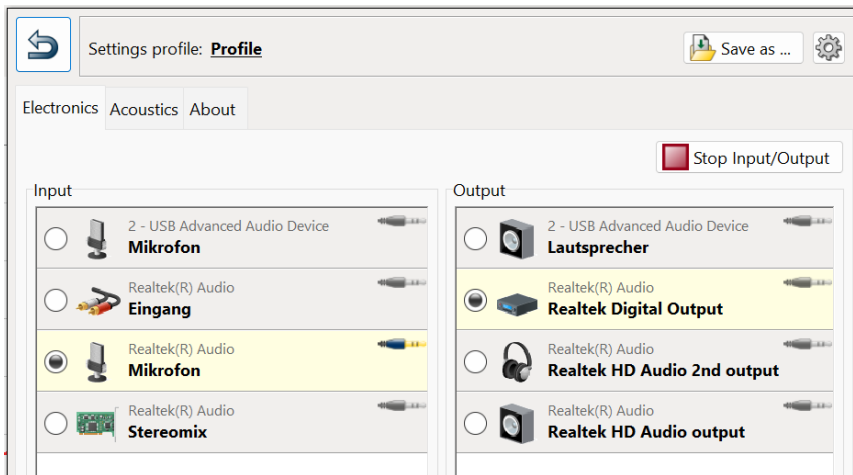
With the waterfall measurement you can see the behavior of the speaker in the room.

Kirchner elektronik

## 17. MEASUREMENT WITH OWN SIGNALS

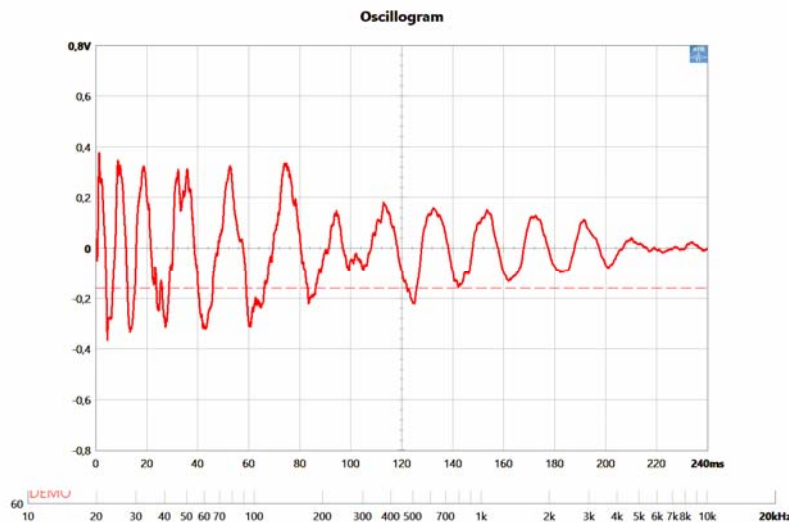
The ATB Audio Analyser program also allows measurements with own signals not included in the program. The program does not import foreign data files that would have to be converted for the program. The measurement signals are played by the program on which they were developed. The measurement is done with one computer. An additional sound card is required. One sound card for playing the signal and one for the input of the measured signal. The ATB can measure foreign signals with the oscilloscope, the SPL and the RTA measurement.

When selecting the sound cards, the playing program is set first. If an additional USB sound card is used, it will be selected automatically. Then the Audio Analyser program is opened and the input of the free sound card is selected.



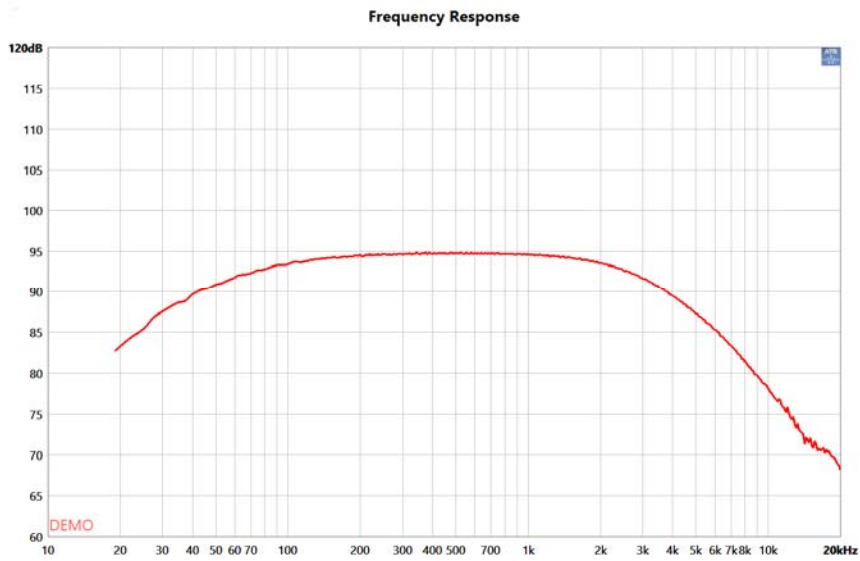
After that the signal can be played back and measured with the ATB.

Example for the oscilloscope measurement. The bass drum signal is played with the Windows Media Player.



The signal shown in the oscilloscope is recorded from a bass drum. This signal shows the transmission behavior very well. It is used, for example, when adjusting a subwoofer. If the signal is displayed correctly, the subwoofer crossover is optimal and the running times are correct.

Another application is the power measurement of a headphone. According to the IRC6068 standard a measurement signal is produced. For this the ATB measurement signal is loaded as .wav in an audio editor or music program. In the program the required frequency response is set with filters. The wav is then played directly.



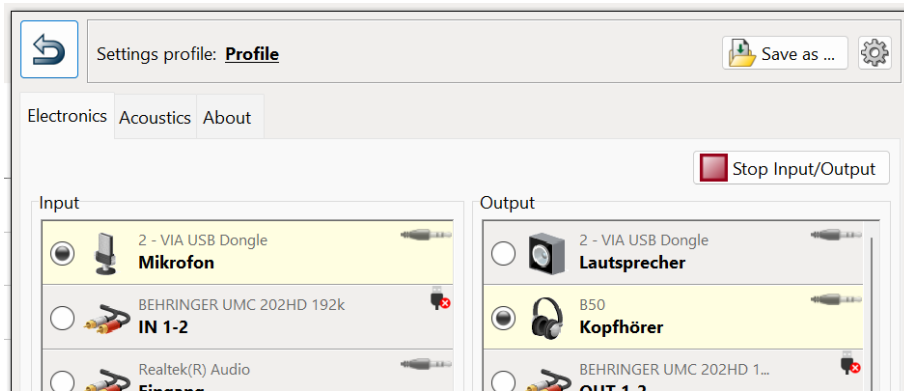
The signals for measurement can also be played back with a device as wav or with the CD player.

## 19. Bluetooth device measurement

The ATB Audio Analyzer also measures Bluetooth devices.

The device to be measured is paired with the PC via Bluetooth.

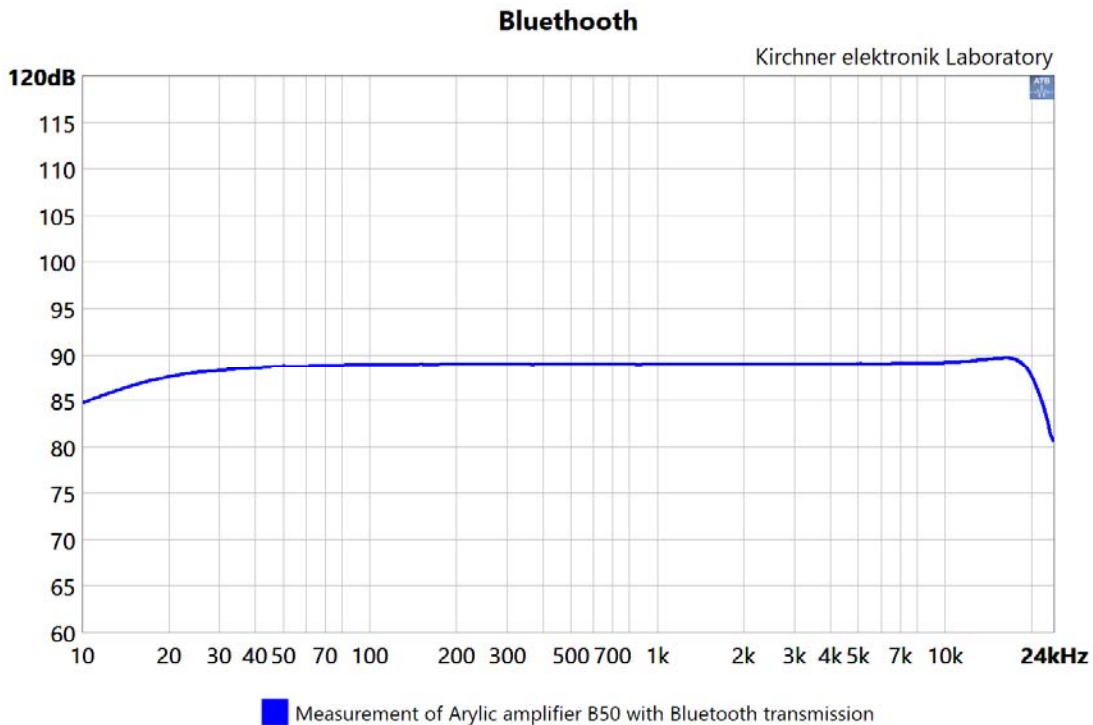
Then the device is selected in the ATB Audio Analyzer program under Setting, Electronics For the output.



In the DistanceMeter menu, the distance, in this case the delay due to the Bluetooth transmission, is measured. This is about 4m.

After that, the frequency response is measured at the speaker output via an adapter that adapts the speaker voltage to the microphone input of the sound card using the SPL measurement. The adapter should also have a protection circuit against too high input voltages for the microphone input.

The sine sweep is used as the measurement signal.



## 19. ANNEX

### 19.1 MEASUREMENTS WITH CD IN THE CAR

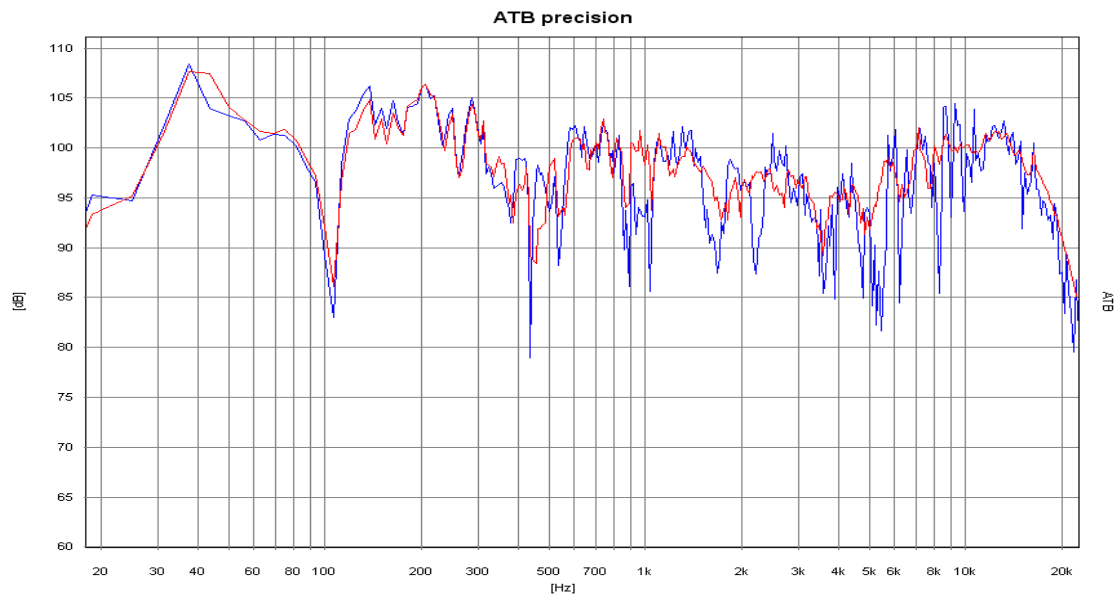
In cars, there is often no input for the measurement signal from the sound card. In this case it is very convenient to play the measurement signal with the Auto-Test CD. The measurement signal can also come as a .wav file from a USB stick.

Attention: The calibration is done as in the normal measurement with the connection of the headphone output to the microphone input of the sound card via the adapter.

The sound card is calibrated before the measurements.

After the measurement, a name is assigned in the settings profile. This profile is then called up for the measurements with the CD.

### 19.2 ROOM CORRECTION

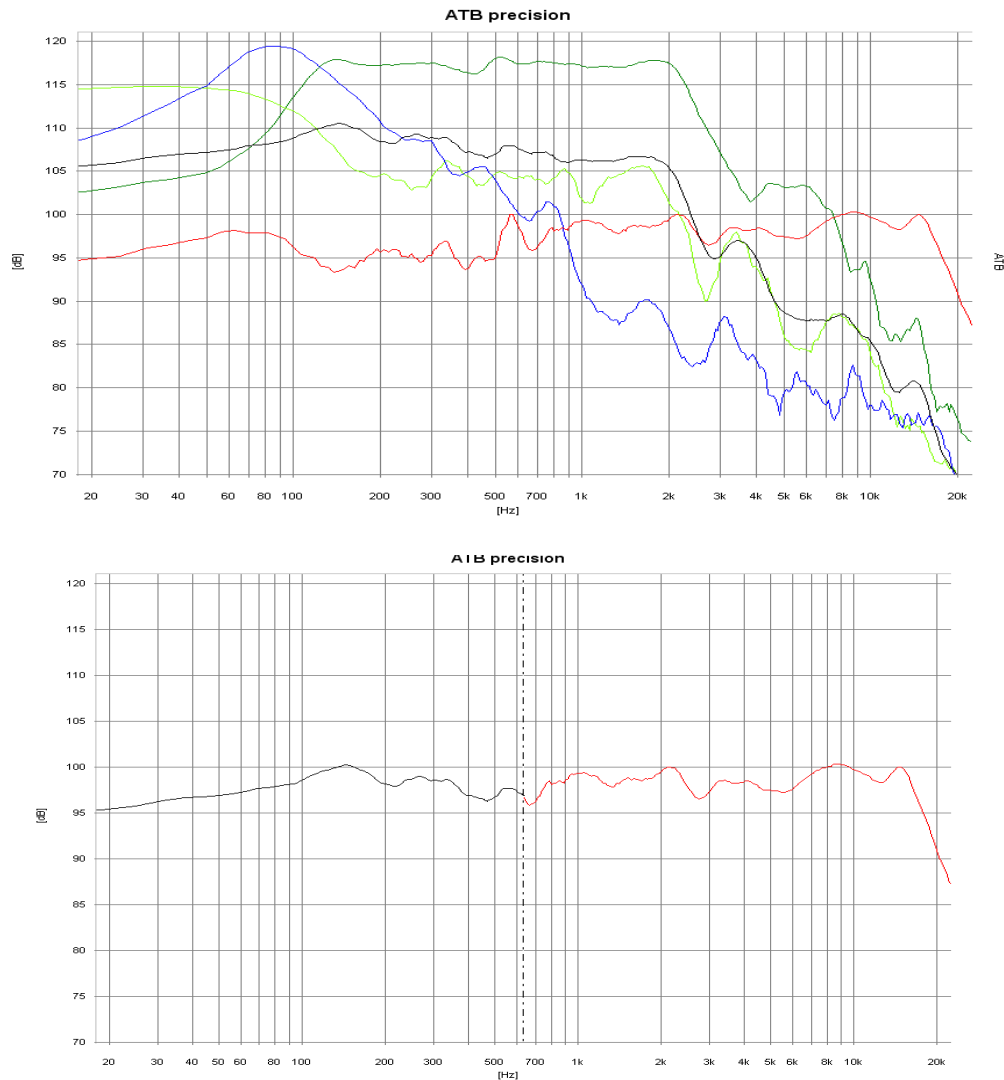


Frequency response in a car blue = single measurement in standard position, red = room-corrected  
Due to the acoustically small interior of a car, the sound is not evenly distributed. The resulting interference of the sound waves shows a different frequency response for each microphone position. A measurement with the standard position shows the interferences, but no meaningful frequency response. Only the measurement with several microphone positions in the head area of the driver shows the frequency response that is decisive for the sound. In the Data Lines menu the measurements are arranged with this button



**Kirchner elektronik**

## 19.3 NEAR-FIELD MEASUREMENT



Near-field measurements: blue = bass, green = mid, red = room-corrected mid-high, light green = bass reflex, black = averaging of bass, mid and bass reflex.

In the low frequency range, the room correction cannot be carried out as described before. To suppress room resonances, the woofer is measured in the near field. With the simple measurement, the result is falsified by the near-field effect, an exaggeration in the sound pressure curve, and the neglect of the sound from the bass reflex port. This is avoided with the ATB PC measurement by moving the microphone between the bass speaker and the reflex port during the measurement. The starting and end points of the movement are the edges of the bass speaker and the bass reflex port. This avoids the influence of the near-field effect. The frequency responses measured during the movement are averaged and show the real bass reproduction. In the "Combine Line" menu of the SPL measurement, the bass and mid-high measurements are combined. The crossover frequency and amplitudes are freely selectable.

## 19.4 SETTING OF THE SURROUND SYSTEM WITH DVD

To set up a surround system, the measurement signals for the 5 channels + the subwoofer are required. These come from the surround test DVD.

For a real cinema experience in the living room, the sound is decisive in addition to the corresponding picture. The speakers are primarily responsible for a good sound. Sound differences between high-quality DVD players and amplifiers exist, but are less important for achieving cinema sound. Much more important are the correct settings for the amplifier and the tuning of the speakers to the room acoustics. This is only possible with measurement technology. Thanks to computers and the ATB-PC programme, even the interested layman is enabled to calibrate his system.

Attention:

The sound card is calibrated before the measurements. At sample rate 48kHz and 16Bit are selected. The calibration is done as in the normal measurement with the connection of the headphone output to the microphone input via the adapter.

After the measurement, a name is assigned in the settings profile. This profile is then called up for the measurements with the DVD.

### **AMPLIFIER**

For operation, the amplifier (receiver) is connected to the TV set.

In the menu of the amplifier (receiver), the menu item SPEAKER SETTING is carried out. Here, all SPEAKERS are set to LARGE and the SUBWOOFER is set to ON.

As a further setting, the volume for all speakers is set to 0dB in CHANNEL BALANCE.

In the CHANNEL DELAYS menu, the different distances to the speakers are set. These settings are necessary because the sound waves in the air travel at the speed of sound. In a surround system, the sound from all speakers should reach the listener at the same time, so this is set in CHANNEL DELAY. In living room systems, the surround speakers are closer to the listener. Therefore, the sound is delayed to be heard at the same time as the sound from the front speaker. For the adjustment, the difference of the distances front loudspeaker - surround loudspeaker is determined and entered into the menu. Some menus require the entry in ms. The ms are calculated with the formula  $1\text{m} = 2.94\text{ms}$ . The values do not need to be set exactly. It is important that the sound is heard first from the front speakers. As a rule of thumb, and for some units only to be set, 10ms applies for small rooms, 15ms for medium rooms and 20ms for large rooms. The centre is delayed by 2-3ms if the setting is possible.

### **MICROPHONE**

The microphone is connected to the MIC socket of the sound card.

Microphone placement:

First, determine where the spectator should sit. The microphone is placed on the back of the sofa or chair so that the microphone head is in the head position of the spectator. If there are two preferred seating positions, the microphone is placed between the positions.

DVD PLAYER

**Kirchner elektronik**

### Connecting the DVD player

The DVD player is connected to the amplifier via its coaxial cinch or optical digital audio output. The video signal is also connected to the amplifier.

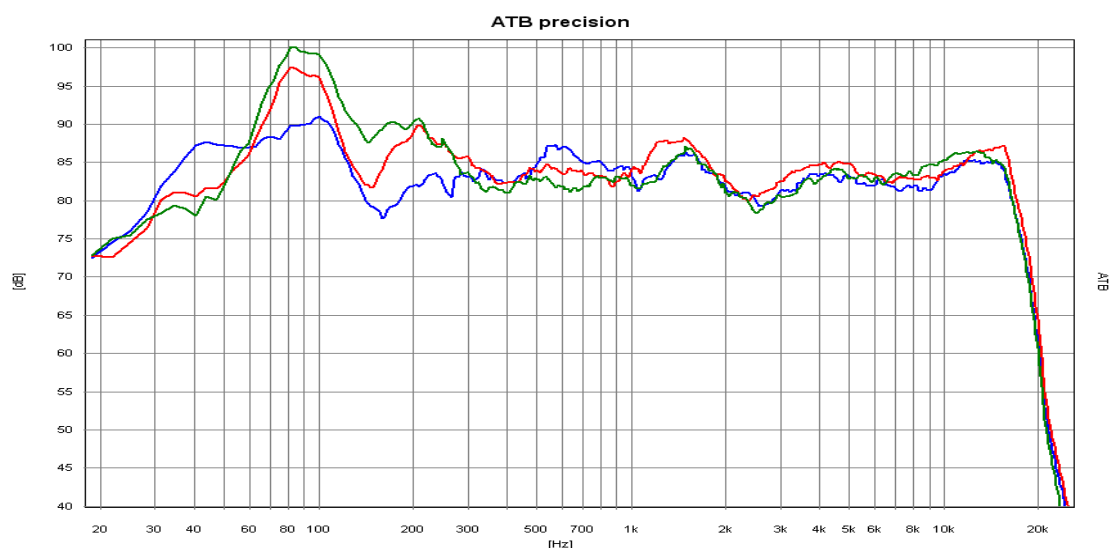
### Starting the Surround Test DVD

The DVD is started and the individual measurements are selected in the menu.

## SINGLE MEASUREMENTS

### Front loudspeaker FL, FR

The measurements are started with the individual measurements of the front loudspeakers FL. This measurement is to test the position of the loudspeaker. The measurement is started in the measuring programme with M D. The volume for the pink noise signal is increased until the frequency response curve is in the upper part of the graph of the measuring programme. The following measurements were carried out in the Leovox Studio. The loudspeakers are systems that have been tried and tested for years and are not only reasonably priced, but also meet all requirements.



The blue curve is the FL loudspeaker, the red curve the FR loudspeaker with a large distance and the green curve with a small distance from the corner of the room.

Now look for the position of the loudspeaker where the frequency response is shown without large peaks or sharp dips. A drop in the high-frequency range is prevented by tilting the loudspeaker in the direction of the sitting position. Exaggerations or dips in the midrange can be compensated by increasing the distance to the adjacent wall. A strong exaggeration in the low frequency range indicates a position in the corner of the room. By increasing the distance to the rear wall, the exaggeration is reduced. In a living room, as a function of the room size, an exaggeration in the bass range cannot be avoided with floor-standing loudspeakers. Since the ear does not react critically to an accentuated bass reproduction, but even finds it pleasant, a compromise between a slight accentuation of the bass and living room friendliness is quite possible. After the FL speaker, FR is placed symmetrically to FR. The symmetrical placement is more important than minor irregularities in the frequency response. The measurement is started with M+D. Different low frequency response from the left and right speaker is not critical, as the audience hears the sum of both speakers.

**Kirchner elektronik**

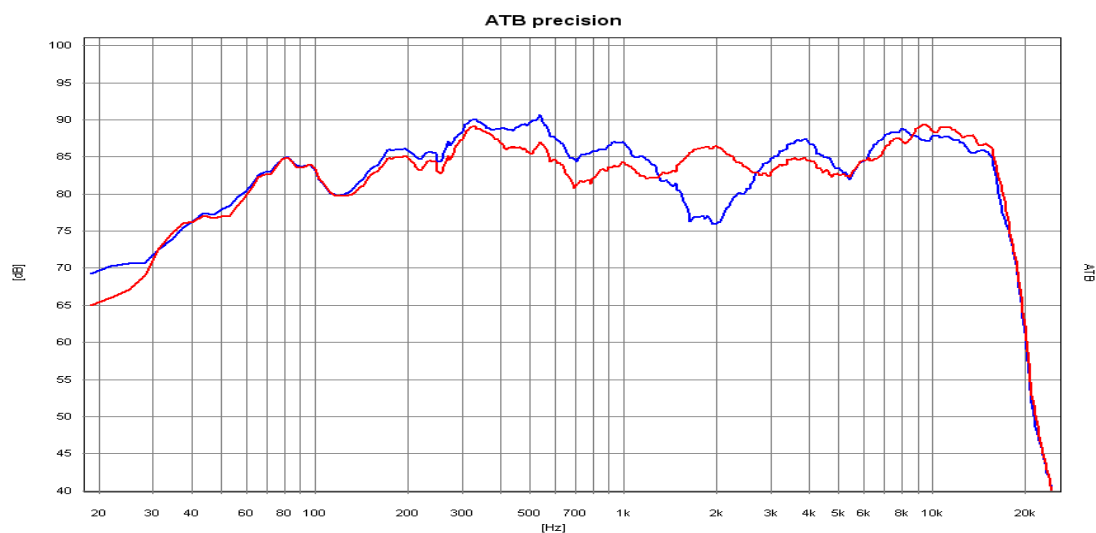


Large dips or peaks in the frequency response of the FR loudspeaker make a new position of the loudspeaker necessary. The new position is then symmetrically transferred to FL and FL is measured. If gross non-linearities now occur at FL, both speakers are placed in a middle position, between the two optimal positions.

Small speakers should be placed in such a way that the sound pressure curve is balanced above 100 Hz.

## Centre

The centre is responsible for speech reproduction. Therefore, a balanced frequency response is important for the centre. The high-frequency reproduction must not be emphasised, otherwise voices will sound too harsh. The low frequency range may drop below 100 Hz, since the low frequency range is transmitted by the subwoofer or the FL, FR speakers.



The curves show the frequency response of the centre with a small distance to the room floor, blue curve. In the red curve, the distance was increased by 20 cm.

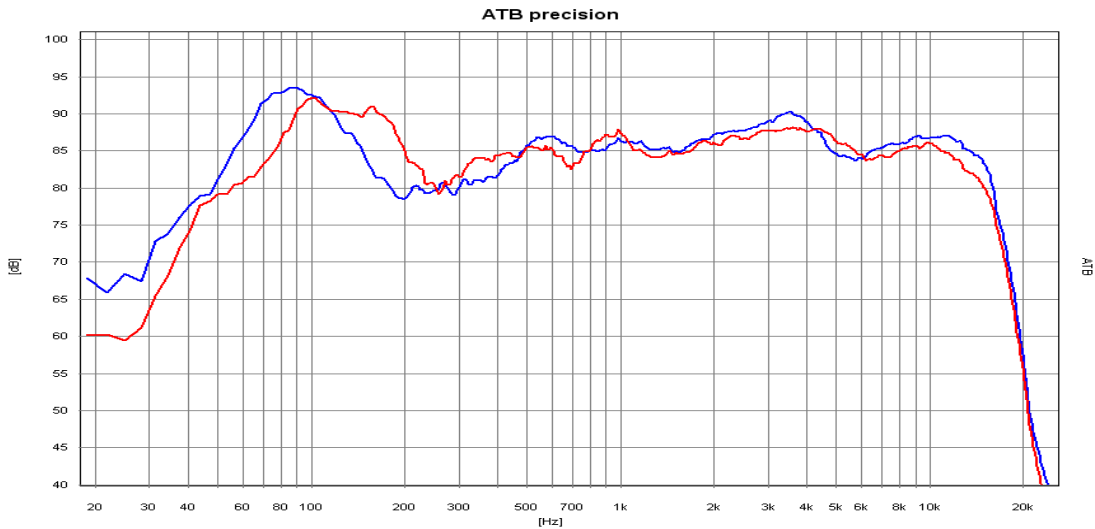
When setting up the centre, the distance to the floor is very important. With the M+D measurement, the centre is measured at different distances from the floor. The distance with the most balanced frequency response should be chosen.

## Surround loudspeaker

Special rules apply to the correct placement of surround speakers. The home cinema owner should be aware that films are not made for the living room, but for the cinema. Just as the picture format does not fit on any television set, the sound is also mixed for the cinema. In the cinema hall, the surround sound is produced by up to 24 small speakers. The speakers are distributed along the walls and back wall of the auditorium. When arranging them, it is important that each member of the audience has a loudspeaker close by and hears a direct sound component. The remaining loudspeakers produce a diffuse sound. These conditions should also prevail in the living room. Since the room does not allow more than two surround speakers, the speakers should be able to radiate direct and diffuse sound. Therefore, the usual direct radiating speakers are not suitable. The dipoles with diffuse sound radiation used in the past for THX are also not favourable.

**Kirchner elektronik**

The frequency response of the surround speakers should be balanced between 100Hz and 10k'Hz. The cut-off frequency of 100Hz allows the low tones emitted in the front to be located in the rear. The high frequency range must not be emphasised. In the cinema, the high-frequency range is limited above 10 kHz, otherwise the individual loudspeaker can be heard. For measuring, the microphone is turned in the direction of the loudspeaker. Measurements are taken with M+D



Special rules apply to the correct placement of surround speakers. The home cinema owner should be aware that films are not made for the living room, but for the cinema. Just as the picture format does not fit on any television set, the sound is also mixed for the cinema. In the cinema hall, the surround sound is produced by up to 24 small speakers. The speakers are distributed along the walls and back wall of the auditorium. When arranging them, it is important that each member of the audience has a loudspeaker close by and hears a direct sound component. The remaining loudspeakers produce a diffuse sound. These conditions should also prevail in the living room. Since the room does not allow more than two surround speakers, the speakers should be able to radiate direct and diffuse sound. Therefore, the usual direct radiating speakers are not suitable. The dipoles with diffuse sound radiation used in the past for THX are also not favourable. The frequency response of the surround speakers should be balanced between 100Hz and 10k'Hz. The cut-off frequency of 100Hz allows the low tones emitted in the front to be located in the rear. The high frequency range must not be emphasised. In the cinema, the high-frequency range is limited above 10 kHz, otherwise the individual loudspeaker can be heard. For measuring, the microphone is turned in the direction of the loudspeaker.

## Measuring the subwoofer

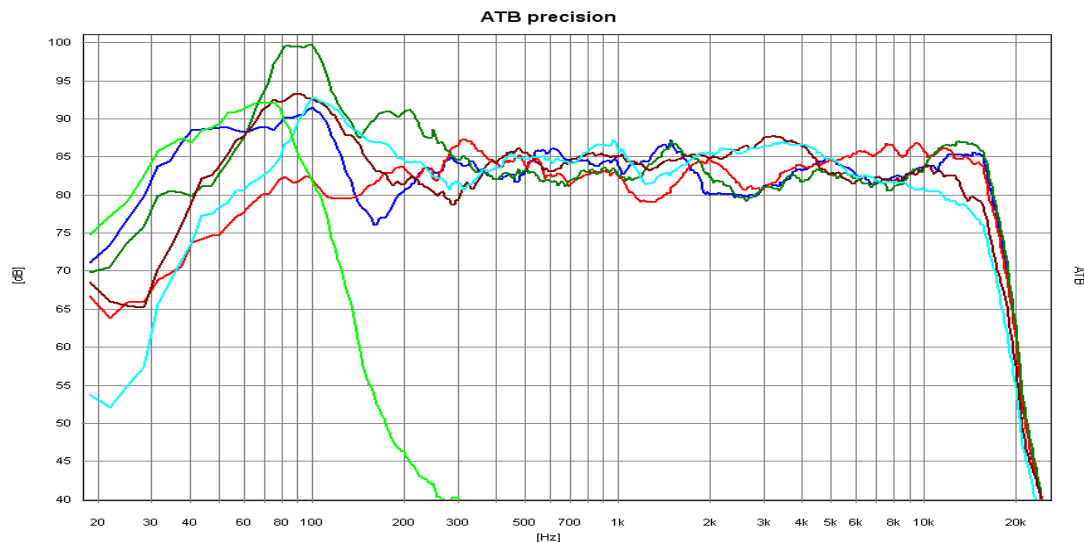
The following measurement is carried out with the single signal SW. The measurement is started with M+D. Measurements are taken with M+D.

The picture shows the curves for the SW with different positions. Here the displacement was 20cm each. The red curve is the FL speaker.

At the same time, placing the subwoofer between the FL and FR speakers is advantageous. By taking several measurements with M+ and moving the subwoofer, the ideal place can be found quickly. This is the place where the measured frequency response curve is highest.

### Setting the volume

The loudspeakers of the surround system must be equally loud. The loudspeakers are measured with the individual signals and the setting is made in the menu of the amplifier under CHANNEL BALANCE. For the FL speaker, 0dB is selected and the sound pressure is measured with M.



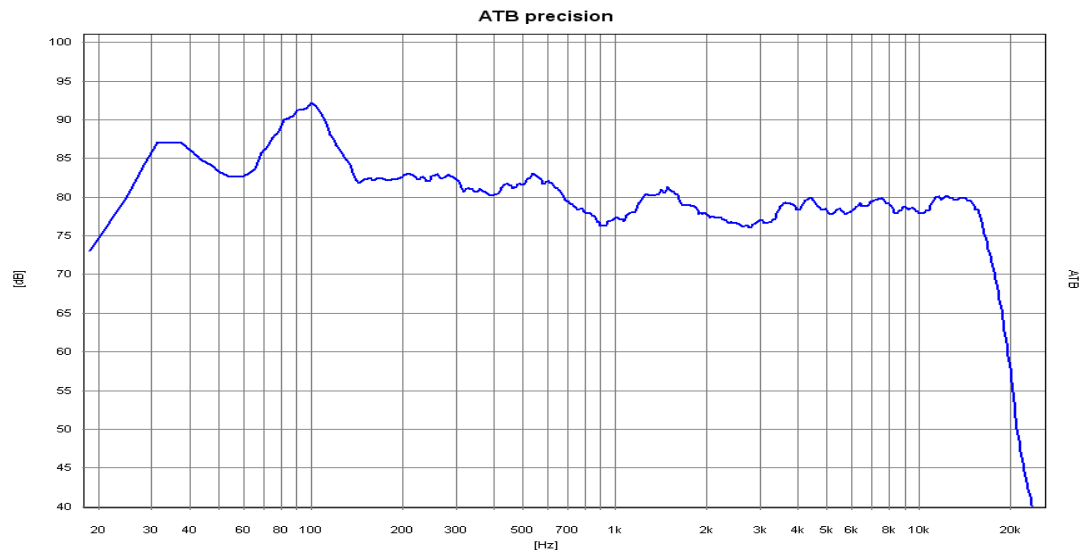
The individual measurements of the speakers shown together

Light green = SW, red = C, green = FR, blue = FL, brown = SR, light blue = SL

The volume corresponds to the height of the sound pressure curve. Then FR is measured with M+ and the setting in the amplifier menu is changed so that the curves lie on top of each other. The same procedure is carried out with the centre and surround speakers. When setting the volume for the subwoofer, the influence of the room must be taken into account. Although a boost is measured at the sitting position, the sound may still be balanced because, averaged over the room, the bass is balanced. The correct measurement is made by comparing the bass curve with the curves of large FL, FR speakers that are balanced in bass. The SW curve should have the amplitude of the large speakers. With small FL, FR speakers, the bass should be set approx. 6dB louder, as it has to take over the low frequency range from the two FL and FR speakers.

## SUM SIGNAL

The measurement of the sum signal of FL and FR shows the interaction of the loudspeakers in the room. From a measurement point of view, a particular difficulty arises during the measurement.



Since the sound waves of the loudspeakers overlap and have exactly the same signal, interference occurs. Dips in the frequency response occur, which depend on the microphone position. These interferences are also audible when the head is moved slightly. This changes the sound of the noise. In order to measure the correct sound pressure curve, the measuring microphone must be moved by hand within 50cm of the seating position. This curve is meaningful for the sound. The measurement is taken with M medium..

Sum signal of the front speakers

The movement of the microphone causes a drop towards the treble. This drop should be even. The measurement with FL+C+FR is important here.

## The equaliser

Some units have an equaliser to adjust the speakers to the room. The sum signals are best suited for adjusting the equaliser because they show the acoustic characteristics of the room. Some rules should be followed when adjusting the equaliser. The problem with the equaliser is that when the frequency response is linearised, the impulse and phase behaviour is changed at the same time. Thus, the temporal allocation of the signals is changed. If the equaliser is used for the FL and FR speakers, the setting should be identical for both speakers. The sum+bass signals are used to adjust the low frequency range.

## SIGNALS+BASS

The Subwoofer

The bass is reproduced in the surround system by subwoofers or large loudspeakers for FL and FR. It is recorded in the Dolby Digital signal as a separate channel. In Dolby Digital, bass is defined as the low tones with a frequency < 100 Hz. Since during recording the bass is picked up by the microphones for FL, Fr, C, SL and SR in the same way, it is separated from the channels and transmitted in the SUB channel. During playback, the sound source for a single tone cannot be located.

**Kirchner elektronik**

Therefore, from a simplified point of view, only one loudspeaker, the subwoofer, is required for playback. The simplified view does not take into account that the cinema sound does not consist of a single signal with one frequency. The sound consists of many frequencies that have a temporal assignment, the phase. Therefore, it cannot be concluded from the simplified view that a subwoofer can be located everywhere in the room. The following measurements will show this. In a system, the subwoofer cannot be considered as a single device because the frequency range around the crossover frequency, 94 Hz, is reproduced simultaneously by the subwoofer and the front and surround speakers. Whenever sound waves overlap, the phase position of the individual waves in relation to each other is decisive for the sound pressure. That's why subwoofers have phase switches or even controls. It has been shown that the correct adjustment of the amplifier and subwoofer can only be achieved by chance without measuring technology. Here, the measurement signals must come from the DVD in order to take into account the characteristics and settings of the Dolby Digital decoder.

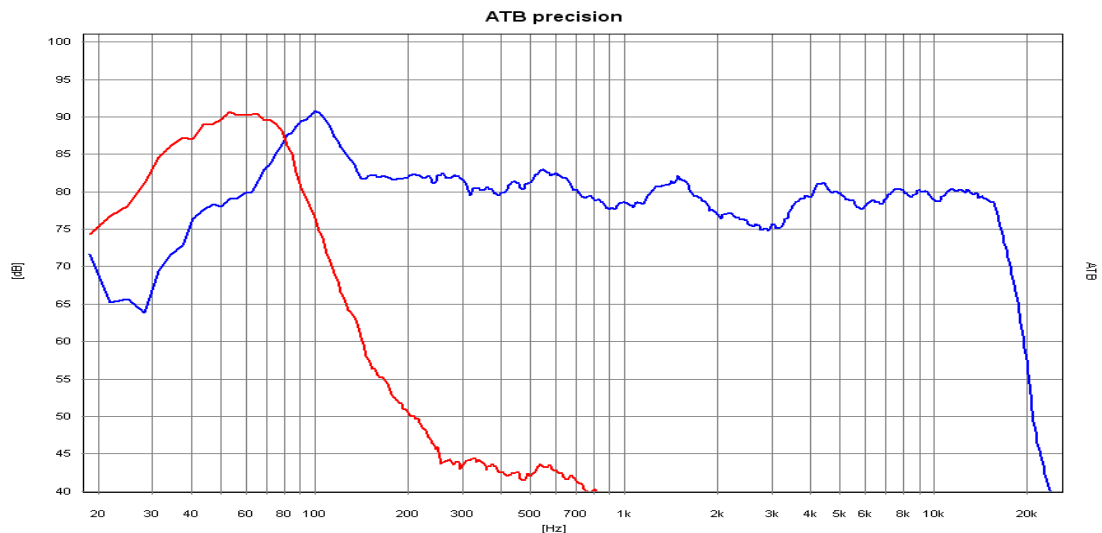
Measuring the sum signal of the front speakers

For this measurement, the subwoofer is switched off, but remains activated in the amplifier menu. The sound pressure is measured with the sum signal FL+C+FR+SW with M means.

Since only the low frequencies are considered for this measurement, the movement of the microphone is not necessary as with the previous sum measurement.

### Measuring the subwoofer

The following measurement is carried out with the single signal SW. The measurement is started with M+D.

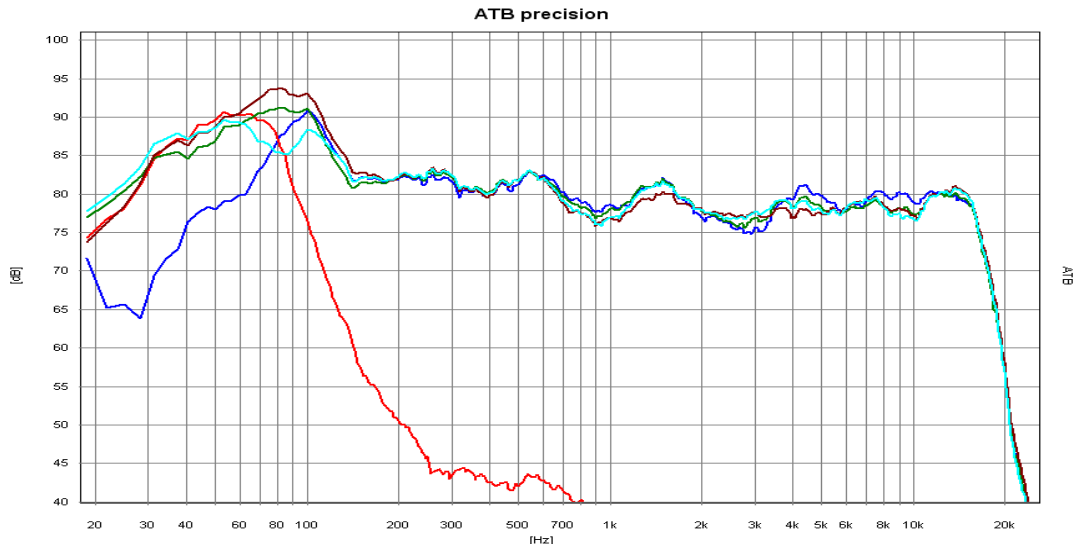


The picture shows the curves for front speakers and SW

During the current measurement, the subwoofer's control for the crossover frequency is operated until the curve for the front speakers and the bass curve behave mirror-inverted symmetrically. The slope of the bass curve, if present, can be adjusted to the slope of the curve for the front speakers with the filter slope control or switch. The intersection of the two curves should be -3dB relative to the curve of the front speakers. The bass curve can be 4db higher than the front speaker curve.

## Measuring the Sum+Bass signal

After the previously described adjustment work, the sum and bass curves fit together when measured separately. Now we have to test how the sound waves overlap. This is determined by the phase behaviour of the individual speakers. With the same phase position the sound waves add up, and with a phase difference of  $180^\circ$  the sound waves cancel each other, there is a dip in the frequency response curve. The phases can be adjusted with the phase control. The measurement is started with the FL+C+FR+SW signal and M+D.



The curves show the interaction of front speakers and subwoofer and the influence of the phase control. Light green, green and brown show the influence of the phase control. The brown curve is the setting without cancellations in the low frequency range.

The irregularities in the midrange and treble range are caused by people moving around in the room.

During the measurement, the phase control is turned until no dip can be seen in the curve. For subwoofers with a phase switch, the setting with the least dip is selected. If there is a dip in both settings, the subwoofer should be positioned differently.

## THE LISTENING TEST

The listening test is a simple way to test the quality of a surround system. The signal for the listening test is a round noise in the room. After calibration, it is also used to fine-tune the system in the CHANNEL BALANCE menu of the amplifier. With an optimal system, the sound moves freely in the room without the sound sources being perceived. At the same time, the noise should sound the same. The first step in fine tuning is to set the volume for the centre. This can be changed in the range of 1-3 dB. If the centre can be heard with the signal running in the front, the volume is lowered. If the noise in the centre is too quiet, the volume for the centre must be increased. The same procedure is carried out with the surround speakers in the next pass. In contrast to the FL and FR speakers, these may also have different volumes.

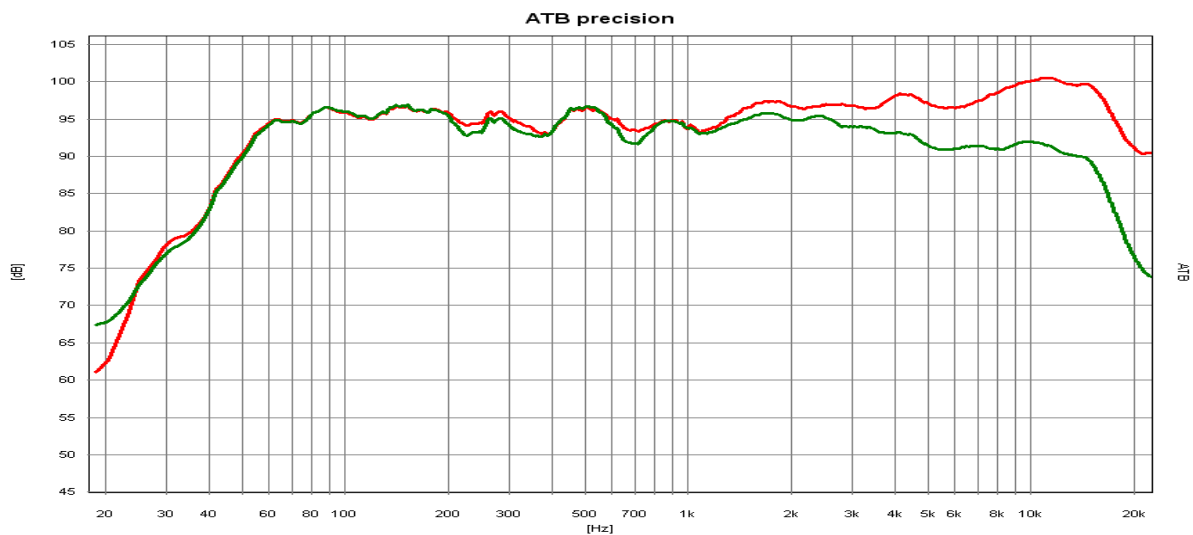
The second signal runs diagonally through the room. This signal places the highest demands on the system. It is used to test the system of a recording studio.

## 18.9 SETTING THE HIFI STEREO SYSTEM

### MICROPHONE

This chapter is aimed at the loudspeaker designer. The ATB Audio Analyzer offers the summation of frequency response measurements, a tool that no developer can do without. The standard measurement signal is 48 kHz and 24 bit.

The usual frequency response measurements are taken with a given microphone position on axis and at an angle. This allows the developer to optimise the frequency response for these positions. To call these graphs the lied frequency response is a bit too harsh a statement. The fact is that speakers with comparable frequency responses sound totally different. The developer arrives at a more meaningful measurement by measuring the radiated energy. This corresponds to what is heard, since in living rooms indirect sound has the greater share. These sound waves, which are reflected from the floor, the wall and the ceiling, must also have a volume corresponding to the music. Therefore, the frequency response of the loudspeaker must be balanced even outside the usual microphone positions. Years ago, the trade magazine HiFi Vision made this meaningful measurement with a rotating microphone. Thanks to the ATB Audio Analyzer measuring programme, the true frequency response can be easily measured with the PC sound card. The programme has the function of summing frequency responses in the SPL measurement. For the microphone, 10 positions are selected at a distance of 60 cm on a circle with a radius of 60 cm. These measurements are summed with the summation function. It shows that an error in the crossover can always be detected.



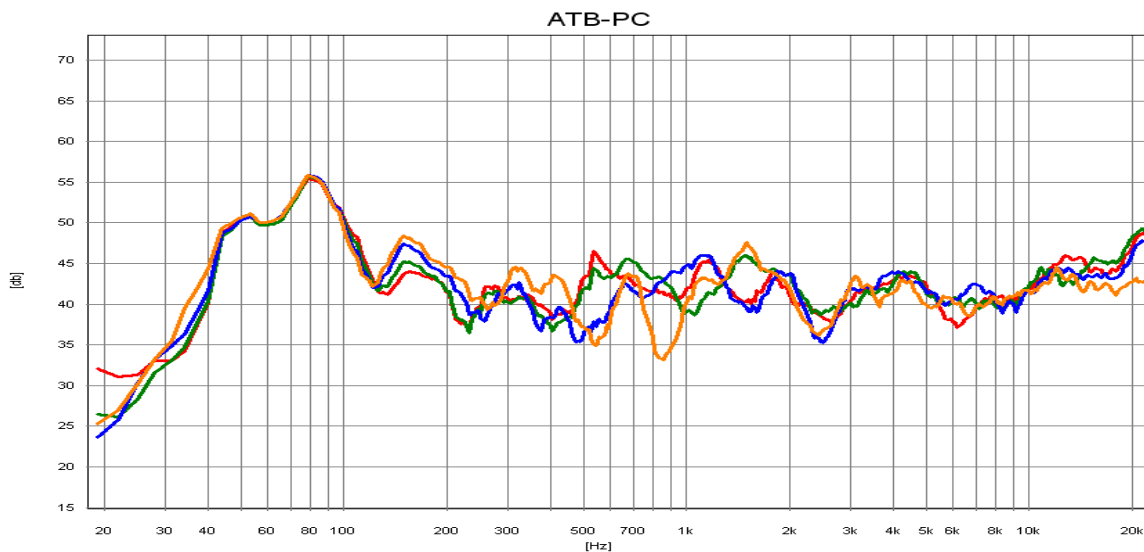
Frequency response of a loudspeaker measured on axis red  
and its correct frequency response green.

In a well-designed loudspeaker, the two curves differ only in the slope of the curve towards the treble. The correctly measured frequency response is also balanced. The drop in the high frequency range is even an advantage in the living room, because a placement close to the wall raises the treble.

### SPEAKER PLACEMENT AND SEATING POSITION

With a stereo system, high demands are made on sound quality and spatial reproduction. First of all, the positioning of the loudspeakers with regard to the distance to the wall should be examined.

**Kirchner elektronik**



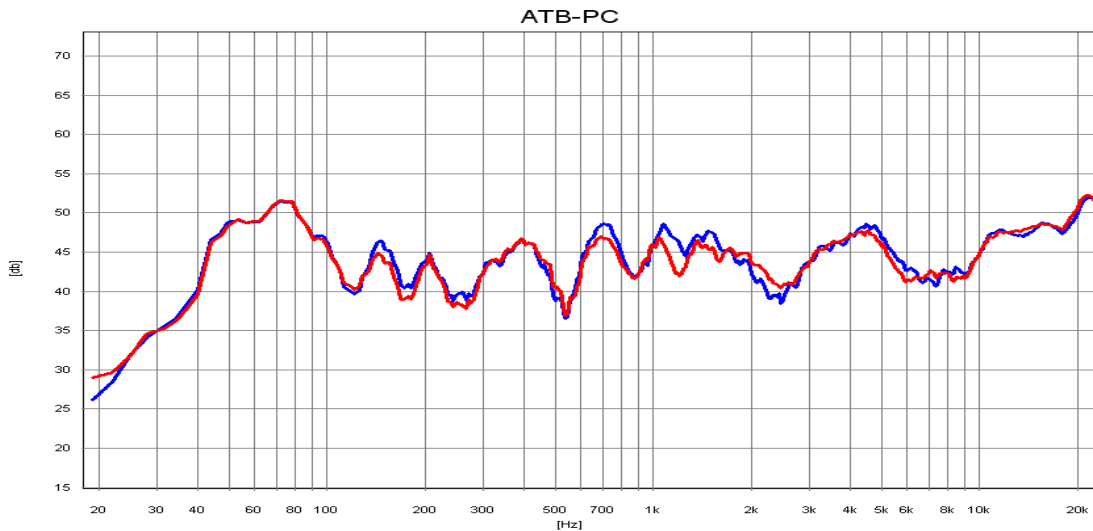
The curves show the frequency response of the speaker in relation to the distance to the side wall. Orange has a distance of 8cm. The jagged curve is clearly visible. The peaks and dips are caused by interference (overlapping) of the direct sound with the sound reflected from the wall. In blue, the distance was increased to 16 cm. The curve is already more balanced. Between green 24cm and red 32cm the difference is not so big. This wall distance should be chosen for this speaker. At the larger distances it is noticeable that there is a strong increase in the high frequencies. This shows that the Omni directional dome tweeter is not the best solution in the living room. The correctly measured frequency responses from the previous chapters, which seem to be unfavourable due to their high frequency drop, show an optimal result for the living room.

If there is not enough space for sufficient wall distance, the wall reflection can be reduced by tapestry or curtains.

For the seating position, the distance to the rear wall is decisive for the midrange. A small distance makes the frequency response in the midrange jagged. This can be prevented by wall carpeting or acoustic mats.

Bei der Sitzposition ist für den Mitteltonbereich der Abstand zur Rückwand entscheidend. Ein geringer Abstand macht den Frequenzgang im mittleren Frequenzbereich zackig. Dies kann durch Wandteppich oder Akustikmatten verhindert werden.

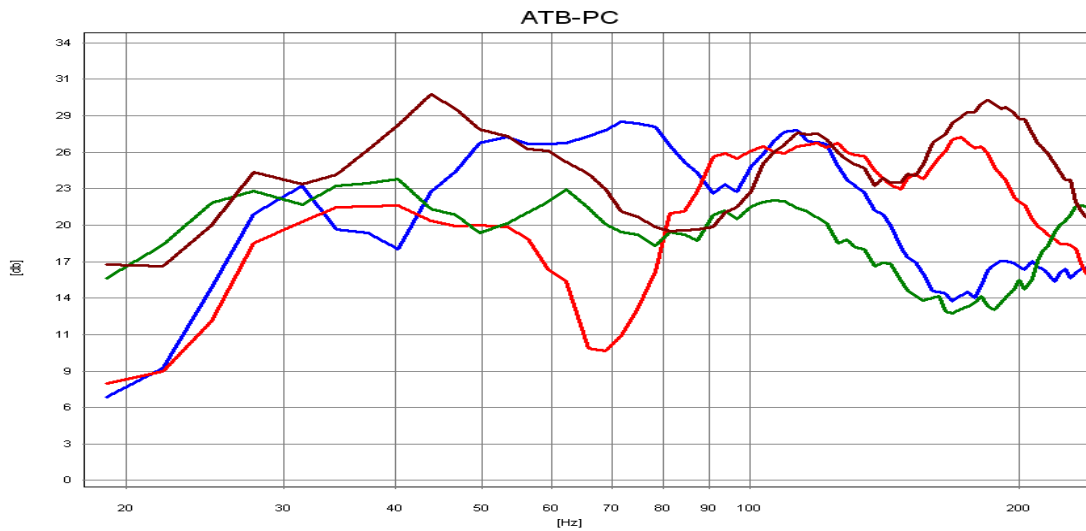




The picture shows the base of the wall behind the seating position. The ripple in the midrange of the blue curve is caused by the interference of the direct sound and the sound reflected from the wall. The sound reflected from the wall is delayed and creates a disturbing reverberation. A layer of nap foam on the back wall reduces the reflections, red curve. The sound becomes more pleasant.

### ROOM ACOUSTICS MEASUREMENTS

Room acoustics describes the sound waves in a room. When a sound wave is generated in a room, the modes are formed. The modes are points at which the sound wave has the lowest or highest energy. This is especially important for the low frequency range. Everyone has had the experience that at a certain point in the room the low tones are weakly audible, while in the same room at another point the low tones are too loud.



The picture shows the frequency responses measured at different positions in the room. The red and brown curves show the modes, while green shows a favourable seating position.

**Kirchner elektronik**

In these measurements, the speaker was in the middle between the main speakers. The measurements show how critical the placement of a subwoofer is.

Further measurements are carried out with special room acoustics measuring programmes. These are mainly used to measure the reverberation time. This value is only important for the acoustician because the reverberation time of a room can only be changed by structural measures.

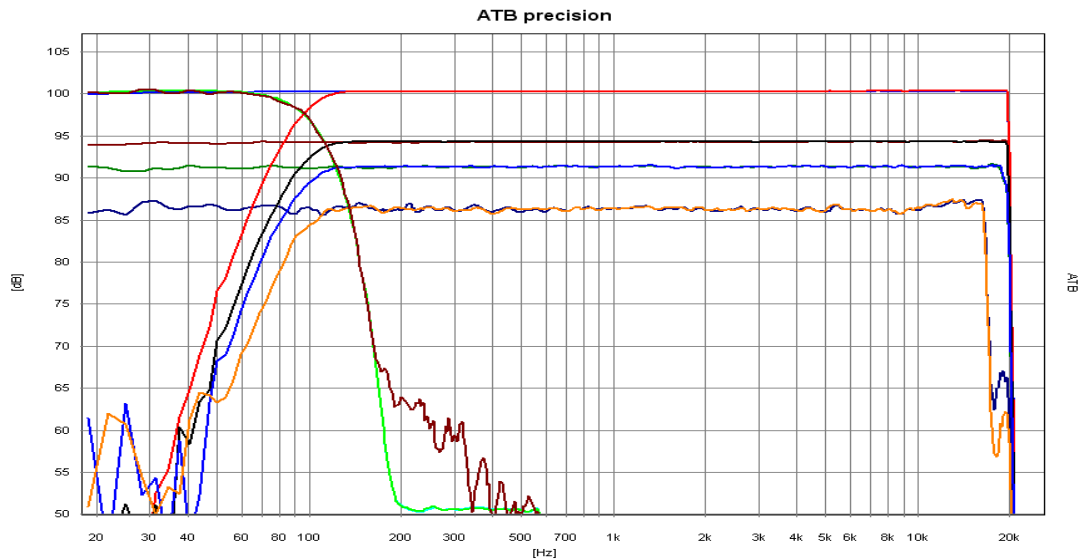
For hi-fi listeners, the measurements of the ATB PC are sufficient to determine the loudspeaker and seating position. The optimum loudspeaker position is reached when the frequency response, measured at the seating position, is balanced. At the seating position, the loudspeaker plus room acoustics are measured.

## 20. ACCESSORIES

### SURROUND-TEST DVD

The measurement signals

The curves of the measurement signals shown were played back from the DVD player and measured with the ATB precision USB.



Die Signale:

- Blau oben = Einzelsignal FL, C, FR, SL, SR
- Hellgrün = Einzelsignal SW,  
beim Surround Verstärker Ausgang +10dB
- Braun = Summsignale FL+FR, SL+SR
- Grün = Summsignal FL+C+FR
- Blau unten = Summsignal FL+C+FR+SL+SR
- Rot = Summsignal+Bass FL, C, FR, SL, SR
- Schwarz = Summsignal+Bass FL+FR, SL+SR
- Blau Mitte = Summsignal+Bass FL+C+FR
- Orange = Summsignal+Bass FL+C+FR+SL+SR
- Braun = Summsignal+Bass SW

The frequency responses, which are no longer completely smooth, result from the high degree of compression of the sum signals.

The PCM signal corresponds to the individual signals with a cut-off frequency of 24 kHz.

The audio signals consist of round and diagonal noise running through the room.

## **POWER AMPLIFIER**

A stable power amplifier is required for loudspeaker measurements. This should have sufficient bandwidth.

## **MICROPHONE**

The microphone should have good linearity and high bandwidth, but it should not be too insensitive. Microphones where the frequency response has to be compensated are not suitable because their impulse behaviour is insufficient.